

Use & Care Guide

Manual de Uso y Cuidado

English / Español

Models/Modelos: 790.3105\*

# Kenmore Elite<sup>®</sup>

## Gas Slide-in Range

## Estufa Deslizable de gas

\* = Color number, número de color

P/N 318205872A (1009)

Sears Brands Management Corporation

Hoffman Estates, IL 60179 U.S.A.

[www.kenmore.com](http://www.kenmore.com)

[www.sears.com](http://www.sears.com)



## Table of Contents

Kenmore Elite Warranty.....	2	Setting Surface Controls.....	11-13
IMPORTANT SAFETY INSTRUCTIONS .....	3-5	Oven Control Functions .....	14
Product Record.....	6	Getting Started.....	15
Serial Plate Location .....	6	Setting Oven Controls.....	16-26
Conversion to Liquefied Petroleum Gas .....	6	User Preferences .....	27
Grounding Instructions.....	6	Self-Cleaning Cycle.....	28-29
Feature at a Glance.....	7	Care & Cleaning.....	30-33
Before Setting Oven Controls .....	8	Before You Call .....	34-36
Surface Cookware Recommendations.....	9	Protection Agreements.....	37
Before Setting Surface Controls .....	10	Sears Service.....	38

---

## Please carefully read and save these instructions

This Use & Care Manual contains general operating instructions for your appliance and feature information for several models. Your product **may not** have all the described features. The graphics shown are representative. The graphics on your appliance may not look exactly like those shown. Common sense and caution must be practiced when installing, operating and maintaining any appliance.

---

## Kenmore Elite Warranty

When installed, operated and maintained according to all instructions supplied with the product, if this appliance fails due to a defect in material and workmanship within one year from the date of purchase, call 1-800-4-MY-HOME® to arrange for free repair.

This warranty applies for only 90 days from the date of purchase if this appliance is ever used for other than private family purposes.

### **This warranty covers only defects in material and workmanship. Sears will NOT pay for:**

1. Cracks in a ceramic glass cooktop that are not a result of thermal shock.
2. Stains and scratches on a ceramic glass cooktop resulting from accident or improper operation or maintenance.
3. Expendable items that can wear out from normal use, including but not limited to filters, belts, light bulbs, and bags.
4. A service technician to instruct the user in correct product installation, operation or maintenance.
5. A service technician to clean or maintain this product.
6. Damage to or failure of this product if it is not installed, operated or maintained according to the all instructions supplied with the product.
7. Damage to or failure of this product resulting from accident, abuse, misuse or use for other than its intended purpose.
8. Damage to or failure of this product caused by the use of detergents, cleaners, chemicals or utensils other than those recommended in all instructions supplied with the product.
9. Damage to or failure of parts or systems resulting from unauthorized modifications made to this product.

### **Disclaimer of implied warranties; limitation of remedies**

Customer's sole and exclusive remedy under this limited warranty shall be product repair as provided herein. Implied warranties, including warranties of merchantability or fitness for a particular purpose, are limited to one year or the shortest period allowed by law. Sears shall not be liable for incidental or consequential damages. Some states and provinces do not allow the exclusion or limitation of incidental or consequential damages, or limitation on the duration of implied warranties of merchantability or fitness, so these exclusions or limitations may not apply to you.

This warranty applies only while this appliance is used in the United States or Canada.

This warranty gives you specific legal rights, and you may also have other rights which vary from state to state.

**Sears Brands Management Corporation, Hoffman Estates, IL 60179 - Sears Canada Inc., Toronto, Ontario, Canada M5B 2B8**

# IMPORTANT SAFETY INSTRUCTIONS

Read all instructions before using this appliance.

Save these instructions for future reference.

This manual contains important safety symbols and instructions. Please pay attention to these symbols and follow all instructions given.



**⚠ WARNING** This symbol will help alert you to situations that may cause serious bodily harm, death or property damage.

**⚠ CAUTION** This symbol will help alert you to situations that may cause bodily injury or property damage.

**⚠ WARNING** If the information in this manual is not followed exactly, a fire or explosion may result causing property damage, personal injury or death.

### FOR YOUR SAFETY:

—Do not store or use gasoline or other flammable vapors and liquids in the vicinity of this or any other appliance.

### —WHAT TO DO IF YOU SMELL GAS:

- Do not try to light any appliance.
- Do not touch any electrical switch; do not use any phone in your building.
- Immediately call your gas supplier from a neighbor's phone. Follow the gas supplier's instructions.
- If you cannot reach your gas supplier, call the fire department.

—Installation and service must be performed by a qualified installer, servicer or the gas supplier.



### ⚠ WARNING

- All appliances can tip.
- Injury to persons could result.
- Install anti-tip bracket packed with unit.
- See Installation Instructions.



To reduce the risk of tipping, the appliance must be secured by properly installed anti-tip bracket provided with the appliance. To check if the bracket is installed properly; grasp the top rear of the appliance and carefully attempt to tilt it forward. Refer to the Installation Instructions for proper anti-tip bracket installation.

• Remove all tape and packaging before using the appliance. Destroy the carton and plastic bags after unpacking the appliance. Never allow children to play with packaging material.

• Proper Installation. Be sure your appliance is properly installed and grounded by a qualified technician in accordance with National Fuel Gas Code ANSI Z223.-latest edition, or in Canada CAN/CGA B149.1, and CAN/CGA B149.2, and the National Electrical Code ANSI/NFPA No.70- latest edition, or in Canada CSA standard, Canadian electrical Code, part 1, and local code requirements. Install only per installation instructions provided in the literature package for this appliance.

• In case of an emergency, know how to disconnect the electrical power to the appliance at the circuit breaker or fuse box.

• User Servicing. Do not repair or replace any part of the appliance unless specifically

recommended in the manuals. All other servicing should be done only by a qualified technician. This may reduce the risk of personal injury and damage to the range. Sears Parts & Repair is the recommended repair service for this appliance.

- Never modify or alter the construction of a range by removing leveling legs, panels, wire covers or any other part of the product.
- Air curtain or other overhead hoods, which operate by blowing a downward air flow on to a range, shall not be used in conjunction with gas ranges other than when the hood and range have been designed, tested and listed by an independent test laboratory for use in combination with each other.

**⚠ WARNING** NEVER use this appliance as a space heater to heat or warm the room. Doing so may result in carbon monoxide poisoning.

# IMPORTANT SAFETY INSTRUCTIONS

**⚠ WARNING** NEVER cover any slots, holes or passages in the oven bottom or cover an entire rack with materials such as aluminum foil. Doing so blocks air flow through the oven and may cause carbon monoxide poisoning. Aluminum foil linings may trap heat, causing a fire hazard.

**⚠ WARNING** Stepping, leaning, sitting or pulling down on the door of this appliance can result in serious injuries and may also cause damage to the appliance. Do not allow children to climb or play around the appliance. The weight of a child on an open door may cause the range to tip, resulting in serious burns or other injury.

**⚠ WARNING** Do not use the ovens for storage.

**⚠ CAUTION** Do not store items of interest to children in the cabinets above an appliance. Children climbing on the appliance to reach items could be seriously injured.

- **Storage on Appliance. Flammable materials should not be stored in an oven, near surface burners.** This includes paper, plastic and cloth items, such as cookbooks, plasticware and towels, as well as flammable liquids. Do not store explosives, such as aerosol cans, on or near the appliance.
- **Do not leave children alone. Children should not be left alone or unattended in the area where an appliance is in use.** They should never be allowed to sit or stand on any part of the appliance.
- **DO NOT TOUCH SURFACE BURNERS, AREAS NEAR THESE BURNERS OR INTERIOR SURFACES OF THE OVEN.** Both surface and oven burners may be hot even though flames are not visible. Areas near surface burners may become hot enough to cause burns. During and after use, do not touch, or let clothing or other flammable materials touch these areas until they have had sufficient time to cool. Among these areas are the cooktop, surface facing the cooktop, the oven vent openings and surfaces near these openings, oven door and window.
- **Wear Proper Apparel. Loose-fitting or hanging garments should never be worn while using the appliance.** Do not let clothing or other flammable materials contact hot surfaces.

- **Do Not Use Water or Flour on Grease Fires. Smother the fire with a pan lid, or use baking soda, a dry chemical or foam-type extinguisher.**
- **When heating fat or grease, watch it closely.** Fat or grease may catch fire if allowed to become too hot.
- **Use Only Dry Potholders. Moist or damp potholders on hot surfaces may result in burns from steam.** Do not let the potholders touch hot heating burners. Do not use a towel or other bulky cloth instead of a potholder.
- **Do Not Heat Unopened Food Containers. Buildup of pressure may cause the container to burst and result in injury.**
- **Remove the oven door from any unused appliance if it is to be stored or discarded.**

**IMPORTANT—Do not attempt to operate the appliance during a power failure.** If power fails, always turn off the appliance. If the appliance is not turned off and the power resumes, it will begin to operate again. Once the power resumes, reset the clock and oven function.

## IMPORTANT INSTRUCTIONS FOR USING YOUR COOKTOP

**⚠ WARNING** Use Proper Flame Size. Adjust flame size so it does not extend beyond the edge of the utensil. The use of undersized utensils will expose a portion of the burner flame to direct contact and may result in ignition of clothing. Proper relationship of utensil to flame will also improve efficiency.

- **Know which knob controls each surface burner.** Place a pan of food on the burner before turning it on, and then turn the burner off before removing the pan.
- **Always turn knob to the full LITE position when igniting top burners.** Visually check that burner has lit. Then adjust the flame so it does not extend beyond the edge of the utensil.
- **Utensil handles should be turned inward and not extend over adjacent surface burners.** To reduce the risk of burns, ignition of flammable materials, and spillage due to unintentional contact with the utensil, the handle of the utensil should be positioned so that it is turned inward, and does not extend over adjacent surface burners

# IMPORTANT SAFETY INSTRUCTIONS

- **Never leave surface burners unattended at high heat settings**—Boilovers cause smoking and greasy accumulations that may ignite, or a pan that has boiled dry may melt.
- **Protective liners**—Do not use aluminum foil to line surface burner pans, or oven bottom, except as suggested in this manual. Improper installation of these liners may result in risk of electric shock, or fire.
- **Glazed cooking utensils**—Only certain types of glass, glass/ceramic, ceramic, earthenware, or other glazed utensils are suitable for cooktop service without breaking due to the sudden change in temperature. Check the manufacturer's recommendations for cooktop use.

## IMPORTANT INSTRUCTIONS FOR USING YOUR OVEN

- **Use Care When Opening an Oven Door**—Stand to the side of the appliance when opening the door of a hot oven. Let hot air or steam escape before you remove or replace food in the oven.
- **Keep Oven Vent Ducts Unobstructed.** The oven is vented at the center trim above the oven and below the console. Touching the surfaces in this area when the oven is operating may cause severe burns. Also, do not place plastic or heat-sensitive items near the oven vent. These items could melt or ignite.
- **Placement of Oven Racks.** Always place oven racks in desired location while oven is cool. Remove all utensils from the rack before removing rack. If rack must be moved while oven is hot, use extreme caution. Use pot holders and grasp the rack with both hands to reposition. Do not let pot holders contact the hot oven burner or interior of the oven.
- **Do not use the broiler pan without its insert.** The broiler pan and grid allow dripping fat to drain and be kept away from the high heat of the broiler.
- **Do not cover the broiler grid or oven bottom with aluminum foil.** Exposed fat and grease could ignite.

- **Do not touch a hot oven light bulb with a damp cloth.** Doing so could cause the bulb to break. Disconnect the appliance or shut off the power to the appliance before removing and replacing the bulb.

## IMPORTANT INSTRUCTIONS FOR CLEANING YOUR RANGE

- **Clean the appliance regularly to keep all parts free of grease that could catch fire.** Exhaust fan ventilation hoods and grease filters should be kept clean. Do not allow grease to accumulate. Greasy deposits in the fan could catch fire. Refer to the hood manufacturer's instructions for cleaning.
- **Kitchen cleaners and aerosols**—Always follow the manufacturer's recommended directions for use. Be aware that excess residue from cleaners and aerosols may ignite causing damage and injury.
- **Clean in the self-cleaning cycle only the parts of the appliance listed in this Use & Care Guide.** Before using the self-cleaning cycle of the appliance, remove the broiler pan and any utensils stored in the appliance.
- **Do not clean the oven door gasket.** The door gasket is essential for a good seal. Care should be taken not to rub, damage or move the gasket.
- **Do not use oven cleaners.** No commercial oven cleaner or oven liner protective coating of any kind should be used in or around any part of the appliance

**⚠ CAUTION** The health of some birds is extremely sensitive to the fumes given off during the self-clean cycle of any oven. Move birds to another well ventilated room.

---

## IMPORTANT SAFETY NOTICE

The California Safe Drinking Water and Toxic Enforcement Act requires the Governor of California to publish a list of substances known to the state to cause cancer, birth defects or other productive harm, and requires businesses to warn customers of potential exposure to such substances.

**SAVE THESE INSTRUCTIONS FOR FUTURE REFERENCE.**

## Product Record

In this space below, record the date of purchase, model and serial number of your product. You will find the model and serial number printed on the serial plate.

Model No. 790.

Serial No. \_\_\_\_\_

Date of purchase \_\_\_\_\_

Save these instructions and your sales receipt for future reference.

## Serial Plate Location

You will find the model and serial number printed on the serial plate. The serial plate is located along the interior side trim and visible when the oven door is opened.

Remember to record the serial number for future reference.

Serial Plate Location

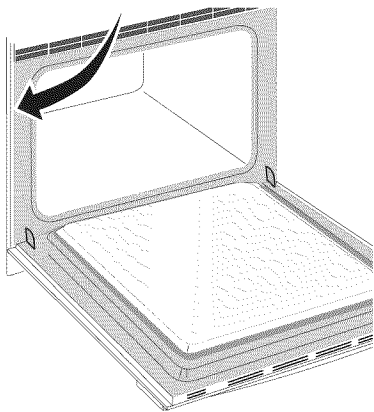

## Conversion to Liquefied Petroleum Gas (or L.P. Gas)

This natural gas range is designed to allow for conversion to Liquefied Petroleum (L.P.) Gas.

Only a qualified service agent should perform the L. P. conversion. Contact the local gas provider for conversion. The L. P. Conversion Kit is supplied with this range and is located on the main back of the range. The kit contains installation instructions which must be read before and followed carefully when installing the kit.

**⚠ WARNING** To avoid serious injury, any additions, changes or conversions required in order for this appliance to satisfactorily meet the application needs must be made by a qualified service agent.

## Grounding Instructions

For personal safety, the cooktop must be properly grounded. For maximum safety, the power cord must be plugged into an electrical outlet that is correctly polarized and properly grounded.

**DO NOT** Operate the cooktop using a 2-prong adapter or an extension cord. If a 2-prong wall receptacle is the only available outlet, it is the personal responsibility of the consumer to have it replaced with a properly grounded 3-prong wall receptacle installed by a qualified electrician. See the **installation instructions** packaged with this cooktop for complete installation and grounding instructions.

**⚠ WARNING** This appliance is equipped with a 3-prong grounding plug for your protection against shock hazard and should be plugged directly into a properly grounded receptacle. **DO NOT** cut or remove the grounding prong from this plug.

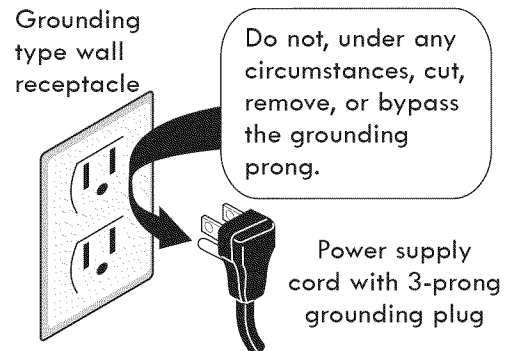

**⚠ WARNING** Avoid fire hazard or electrical shock. **DO NOT** use an adapter plug, an extension cord, or remove grounding prong from electrical power cord. Failure to follow this warning can cause serious injury, fire or death.

# Features at a Glance

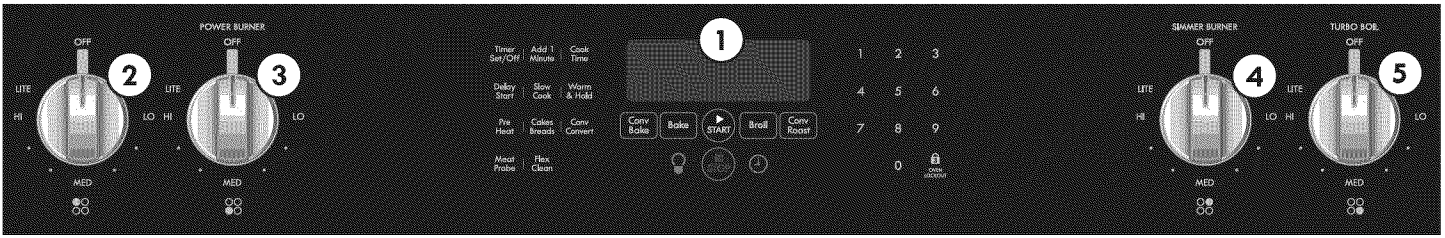

## Your Range includes:

1. Electronic oven control with kitchen timer.
2. Left rear burner valve and knob.
3. Left front burner valve and knob.
4. Right rear burner valve and knob.
5. Right front burner valve and knob.
6. Self-clean door latch.
7. Cooling fan vent.
8. Broil burner.
9. Self-cleaning convection oven interior.
10. Convection bake cooking system.
11. Adjustable interior porcelain oven rack(s).
12. Large 1-piece oven door handle.
13. Full width oven door with window.
14. Storage drawer.
15. Cast iron grates.
16. 14 200 BTU power burner.
17. Oven vent decorative cover.
18. 5 000 BTU simmer burner.
19. 9 500 BTU burner.
20. 18 000 BTU turbo boil burner.
21. Deep drawn cooktop.

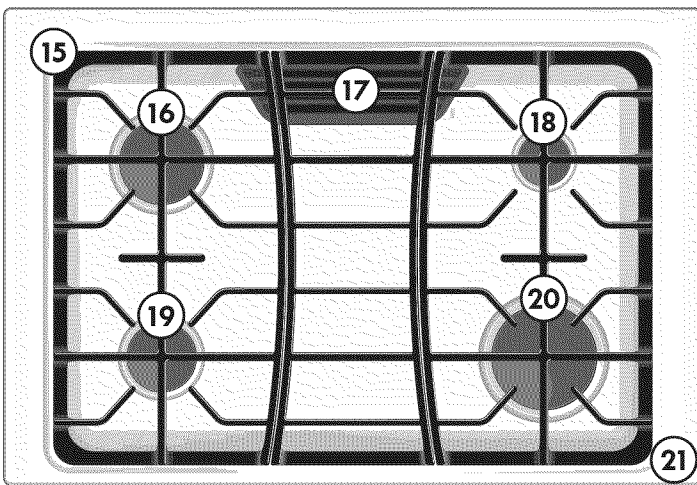
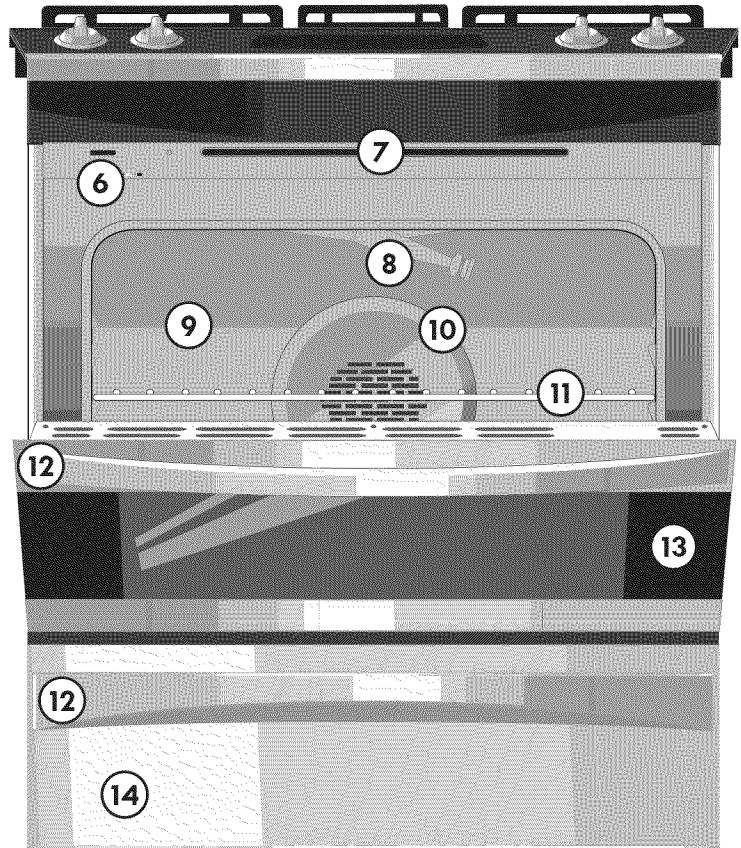

**NOTE:** The features of your range may vary according to model type & color.

# Before Setting Oven Controls

## Oven Vent Location

The oven is vented in the center rear on the cooktop. When the oven is on, warm air is released through the vent. This venting is necessary for proper air circulation in the oven and good baking results. **DO NOT BLOCK OVEN VENT.**

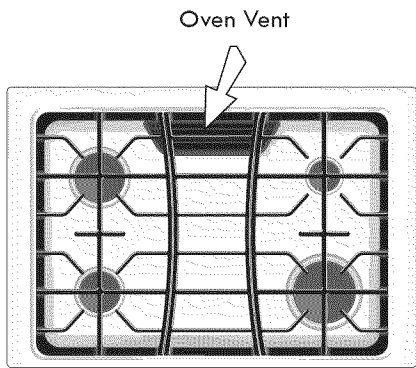

**CAUTION** Some models are equipped with a blower which runs in baking and self-cleaning mode to keep all internal components at a cool temperature. The blower may keep running even if the oven has been turned off, until the components have cooled down.

## Arranging Oven Racks

**CAUTION** Always use pot holders or oven mitts when adjusting the oven racks. Wait until the oven has completely cooled if possible. Oven racks may be HOT and cause burns.

**To remove an oven rack,** pull the rack forward until it stops. Lift up front of rack and slide out.

**To replace an oven rack,** fit the rack onto the guides on the oven walls. Tilt the front of the rack upward and slide the rack back into place.

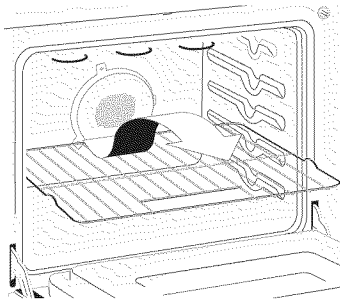

## Air Circulation in the Oven

If using 1 rack, place in center of oven. If using multiple racks, stagger cookware as shown.

For best air circulation and baking results allow 2-4" (5-10 cm) around the cookware for proper air circulation and be sure pans and cookware do not touch each other, the oven door, sides or back of the oven cavity. The hot air must circulate around the pans and cookware in the oven for even heat to reach around the food.

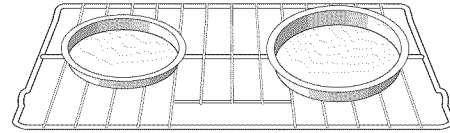

1 Oven Rack

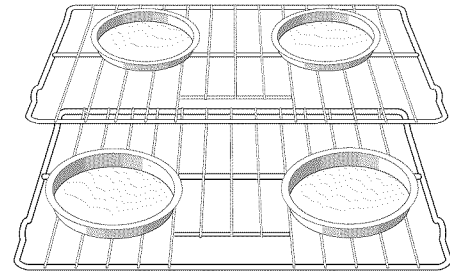

Multiple Oven Racks



# Surface Cookware Recommendations

## Use Proper Cookware

Cookware should have flat bottoms that make good contact with the cooktop grate. Check for flatness by rotating a ruler across the bottom of the cookware (See Figure 1). Be sure to follow the recommendations for using cookware as shown in Figure 2.

**Note:** The size and type of cookware used will influence the setting needed for best cooking results.

**Note:** Always use a utensil for its intended purpose. Follow manufacturer's instructions. Some utensils were not made to be used in the oven or on the cooktop.

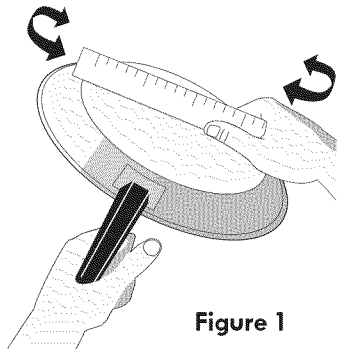
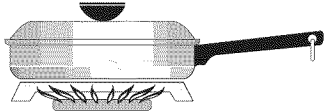

Figure 1

### CORRECT



- Flat bottom and straight sides.
- Tight fitting lids.
- Weight of handle does not tilt pan. Pan is well balanced.
- Pan sizes match the amount of food to be prepared.
- Made of material that conducts heat well.
- Easy to clean.

### INCORRECT

- Curved and warped pan bottoms.

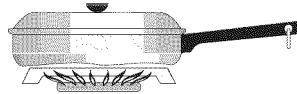

- Pan overhangs unit by more than 2.5 cm (1").

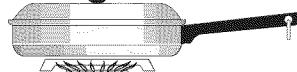

- Heavy handle tilts pan.

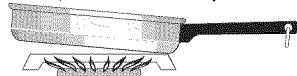

- Flame extends beyond unit.

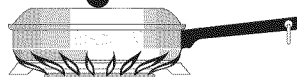

Figure 2

\* Specialty pans such as lobster pots, griddles and pressure cookers may be used but must conform to the above recommended cookware requirements.

## Cookware Material types

The cookware material determines how evenly and quickly heat is transferred from the surface unit to the pan bottom. The most popular materials available are:

**ALUMINUM** - Excellent heat conductor. Some types of food will cause it to darken (Anodized aluminum cookware resists staining & pitting).

**COPPER** - Excellent heat conductor but discolors easily.

**STAINLESS STEEL** - Slow heat conductor with uneven cooking results. Is durable, easy to clean and resists staining.

**CAST IRON** - A poor heat conductor however will retain heat very well. Cooks evenly once cooking temperature is reached.

**PORCELAIN-ENAMEL on METAL** - Heating characteristics will vary depending on base material.

**GLASS** - Slow heat conductor.

## Using a Wok (not supplied)

Woks with flat bottoms suitable for use on your cooktop are available in most cookshop or hardware stores. Round-bottomed woks (with a support ring that does not extend beyond the burner unit) may also be used. The metal ring was designed to support the wok safely when it is filled with large amounts of liquids (soup making) or fat (frying).

**Wire trivets:** Do not use wire trivets. Cookware bottoms must be in direct contact with the grates.

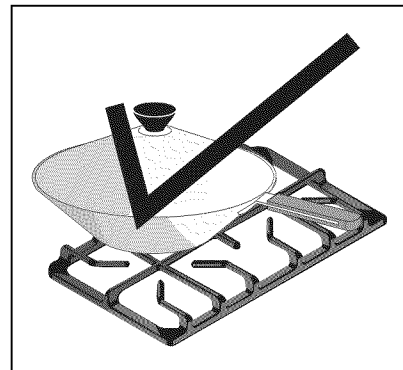

**DO NOT** use a wok if it is equipped with a metal ring that extends beyond the burner unit. Because this ring traps heat, the surface unit and cooktop surface could be damaged.

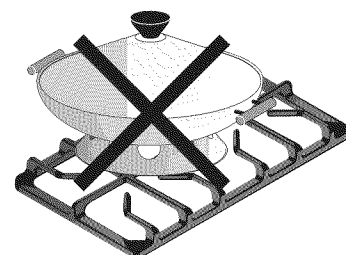

# Before Setting Surface Controls

## Check Burner Cap Placement Before Operating the Surface Burners

To prevent flare-ups and avoid creation of harmful by-products, **do not** use the cooktop without all burner caps properly installed to insure proper ignition and gas flame size.

**It is very important** to be sure that all surface burner caps and burner grates are properly installed and in the correct locations **BEFORE** operating the cooktop burners.

### Remember:

- Always keep surface burner caps in place whenever using a surface burner.
- When placing the burner caps, be sure that all burner caps are **seated firmly and rest level on top of burner heads.**
- For proper flow of gas and ignition of burners **DO NOT** allow spills, food, cleaning agents or any other material to enter the gas orifice port opening.

### Round Style Burners

The burner cap lip (See Fig. 1) should fit snug into the center of burner head and rest level. Refer to Figs. 2 & 3 for correct and incorrect burner cap placement. Once in place, you may check the fit by gently sliding the burner cap from side to side (Fig. 4) to be sure it is centered and firmly seated. When the burner cap lip makes contact inside the center of the burner head you will be able to hear the burner cap click. Please note that the burner cap should **NOT** move off the center of the burner head when sliding from side to side.

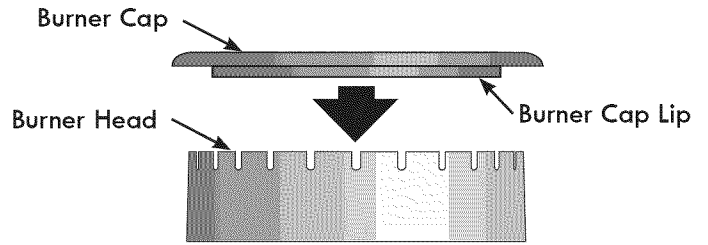
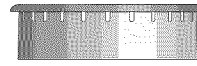

Fig. 1



Correct Burner Cap Placement

Fig. 2



Incorrect Burner Cap Placement

Fig. 3

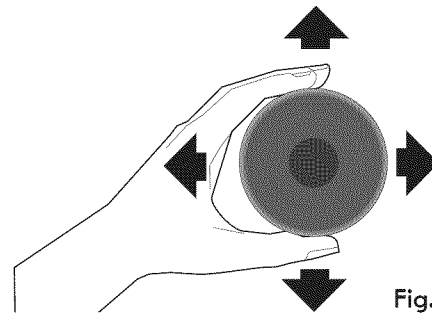

Fig. 4

# Setting Surface Controls

## Setting Proper Surface Burner Flame Size

For most cooking, start on the highest control setting and then turn to a lower one to complete the process. Use the recommendations below as a guide for determining proper flame size for various types of cooking. The size and type of utensil used and the amount of food being cooked will influence the setting needed for cooking.

*Flame Size	Type of Cooking
High Flame	Start most foods; bring water to a boil; pan broiling.
Medium Flame	Maintain a slow boil; thicken sauces, gravies; steaming.
Low Flame	Keep foods cooking; poach; stewing.

\*These settings are based on using medium-weight metal or aluminum pans with lids. Settings may vary when using other types of pans. The color of the flame is the key to proper burner adjustment. A good flame is clear, blue and hardly visible in a well-lighted room. Each cone of flame should be steady and sharp. Clean burner if flame is yellow-orange.

Regardless of size, always select cookware that is suitable for the amount and type of food being prepared. Select a burner and flame size appropriate to the pan. Never allow flames to extend beyond the outer edge of the pan.

Never extend the flame beyond the outer edge of the utensil. A higher flame wastes heat and energy and increases your risk of being burned by the flame (Figure 1).

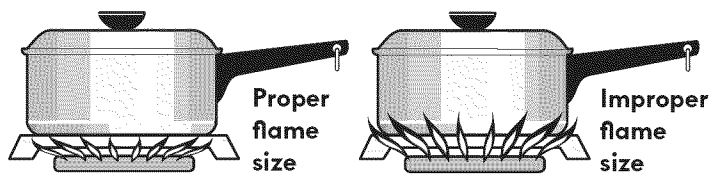

Figure 1

For deep fat frying, use a thermometer and adjust the surface control knob accordingly. If the fat is too cool, the food will absorb the fat and be greasy. If the fat is too hot, the food will brown so quickly that the center will be undercooked. Do not attempt to deep fat fry too much food at once as the food will neither brown nor cook properly.

**CAUTION** Do not place items such as aluminum foil, salt and pepper shakers, spoon holders or plastic wrappings on top of the range when it is in use. These items could melt or ignite. Potholders, towels or wood spoons could catch fire if placed too close to a flame.

## Manual Lighting

In the event of an electrical power outage, the surface burners can be lit manually. To light a surface burner, hold a lit match to the burner head, then slowly turn the surface control knob to **LITE**. After burner lights push in and turn knob to desired setting. Use caution when lighting surface burners manually.

## Setting the Regular or Simmer Burners

1. Place cooking utensil on surface burner.
2. Push the surface control knob down and turn **counterclockwise** out of the OFF position (See Figure 2).
3. Release the knob and rotate to the LITE position.
4. **Visually check that the burner has a flame.**
5. Once the burner is lit, continue to turn **counterclockwise** to the desired flame size. The control knobs do not have to be set at a particular setting. Use the knob indicator settings to adjust the flame as needed.

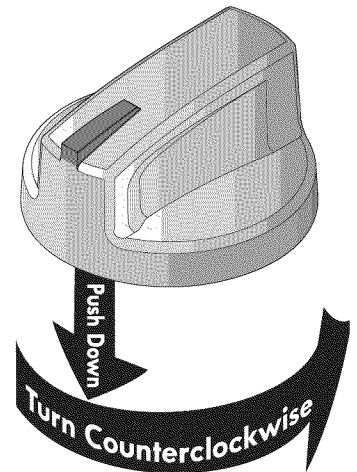

Figure 2

### Important notes:

- **DO NOT** cook with the surface control knob left in the LITE position. (The electronic ignitor will continue to spark if the control knob setting remains in the LITE position).
- When setting any surface control knob to the LITE position, all electronic surface ignitors will spark at the same time. However, only the surface burner you are setting will ignite.
- **NEVER** place or straddle a cooking utensil over two different surface cooking areas at the same time. This can cause uneven heating results.

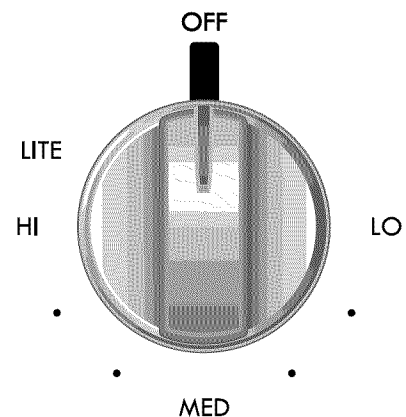
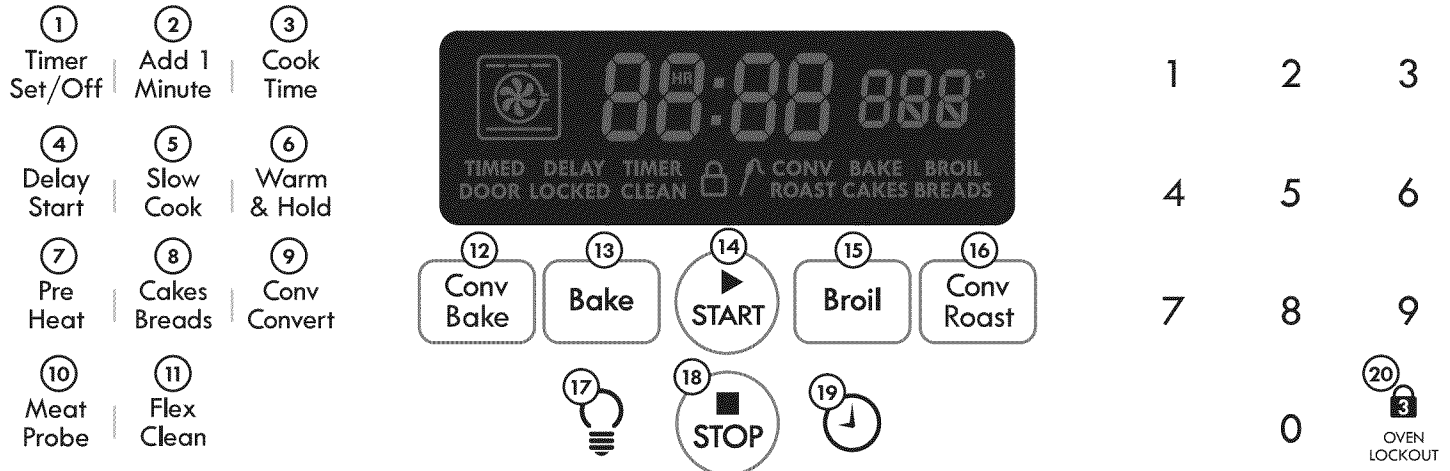

Figure 3 - Regular or Simmer Burner Control

# Oven Control Functions

For satisfactory use of your oven, become familiar with the various features and functions of the oven.



## Oven Control Keypads

- 1. Timer Set/Off** - Used to set or cancel Timer.
  - 2. Add 1 Minute** - Used to add additional minutes to Timer.
  - 3. Cook Time** - Used to enter the length of the cook time desired.
  - 4. Delay Start** - Used with Bake, Conv Bake, Conv Convert and Flex Clean functions to program a delay start time or delay start self-cleaning cycle.
  - 5. Slow Cook** - Used to select the Slow Cook function.
  - 6. Warm & Hold** - Used to set the Warm & Hold function.
  - 7. Preheat** - Used to pre-condition the oven.
  - 8. Cakes or Breads** - Used to select the cakes or breads.
  - 9. Conv Convert** - Used to select the Convection Convert function.
  - 10. Meat Probe** - Used to set Meat Probe.
  - 11. Flex Clean** - Used to set a 2 to 4 hours Self-Clean cycle.
  - 12. Conv Bake** - Used to select the Convection Bake feature.
  - 13. Bake** - Used to enter the normal bake feature.
  - 14. START** - Used to start oven functions.
  - 15. Broil** - Used to select Broil feature.
  - 16. Conv Roast** - Used to select the Convection Roast function.
  - 17. Oven Light** - Used to turn oven light ON and OFF.
  - 18. STOP** - Used to cancel any oven function previously entered except Clock and Timer.
  - 19. Clock Set** - Used to set the time of day.
  - 20. Oven Lockout** - Used to lock oven functions and door.
- 0 thru 9 number** - Used to enter temperature and times.

## Minimum & maximum control settings

All of the features listed below have minimum and maximum time or temperature settings that may be entered into the control. An ENTRY acceptance beep will sound each time a control pad is touched (the Oven Lockout pad is delayed 3 seconds). An ENTRY ERROR tone (3 short beeps) will sound if the entry of the temperature or time is below the minimum or above the maximum settings for the feature.

Feature	Min. Temp. or time	Max. temp. or time
PreHeat	170°F/77°C	550°F/288°C
Bake	170°F/77°C	550°F/288°C
Broil	400°F/205°C	550°F/288°C
Timer	0:01 Min.	11:59 Hr./Min.
Flex Clean	2 hours	4 hours
Conv Bake	300°F/149°C	550°F/288°C
Conv Convert	300°F/149°C	550°F/288°C
Conv Roast	300°F/149°C	550°F/288°C
Slow Cook	Lo (225°F/180°C)	Hi (225°F/180°C)
Cook Time	0:01 Min.	11:59 Hr./Min.
Delay Time 12 Hr.	1:00 Hr./Min.	12:59 Hr./Min.
Delay Time 24 Hr.	0:00 Hr./Min.	23:59 Hr./Min.

## Recommended Rack Position for Broiling, Baking and Roasting

Food	Rack Position
Broiling meats, chicken or fish	3 or 4
Cookies, cakes, pies, biscuits & muffins	
Using 1 rack	2 or 3
Using multiple racks	2 and 4
Frozen pies, angel food cake, yeast, bread, casseroles, small cuts of meat or poultry	1 or 2
Turkey, roast or ham	1

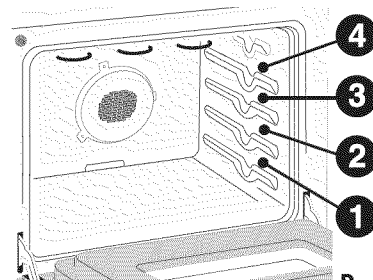

Rack positions

# Getting Started

## Setting Clock at Power Up

You will be prompted to enter the time of day in the event of a power failure or when you first provide electric power to your appliance.

- When your appliance is first powered up, 12:00 will flash in the display.
- Enter the time of day using the numeric key pads and press **START** to set.

If an invalid time of day is entered, the control will triple beep. Re-enter a valid time of day and press **START**. If **STOP** is pressed your clock will start with the time set for **12:00**.

Select the **CLOCK**  key to modify the time of day during other situations such as day light savings.

## Setting Timer

The timer provided with the oven control serve as extra reminders in the kitchen. When the timer reaches less than 1 minute the display will start to count down in seconds. When the time runs out the active timer will beep, and “End” will be displayed.

The following time settings apply to the timers:

- Min. time: 1 minute
- Max. time: 11 hours 59 minutes

See example below to set the timer for 5 minutes:

1. Press **TIMER SET/OFF**
2. Enter **5** minutes
3. Press **START**

To cancel or end the timer, press the **TIMER SET/OFF** key again.

**NOTE:** The timer(s) will not affect the cooking process.

## To Set Add 1 Minute Feature

The ADD 1 MINUTE pad is used to set the Add 1 Minute feature. When the pad is pressed, 1 minute is added to the Timer feature if this feature is already active. If the Timer feature is not active and the pad is pressed, the Timer feature will become active and will begin counting down from 1 minute. For further information on how to set the Timer feature see Timer instructions above.

## Preheat Temperature Display

Once a cooking feature has been started, the control will display the actual oven temperature while preheating. Once the oven reaches the oven set temperature, only the oven set temperature will be displayed.

The preheat temperature display is available with the following cooking modes:

- Bake
- Conv Bake

## Setting Oven Lockout

The Oven Lockout feature automatically locks the oven door and prevents the oven from being turned on. It does not disable the clock, Timer or the interior oven lights.

See example below to lock the oven.

To lock, press and hold **OVEN LOCKOUT** for 3 seconds.

To unlock, press and hold **OVEN LOCKOUT** for 3 seconds.

**DOOR LOCKED** will flash in the display until the door has finished locking. Once the door has been locked the door lock indicator will turn on. **DOOR LOCKED** will then stay displayed.

Do not attempt to open the oven door while the door lock indicator is flashing.

# Setting Oven Controls

## Preheat

For best baking performance use the **Preheat** feature. The Preheat feature will bring the oven up to the set cooking temperature. A reminder tone will sound indicating when the set temperature is reached and to place the food in the oven. Preheating is not necessary when roasting or cooking casseroles.

The following temperature settings apply to the preheat feature:

- Auto-suggest (default) setting: **350°F/177°C**
- Min. bake setting: **170°F / 77°C**
- Max. bake setting: **550°F / 288°C**

## Setting preheat

See example below to set a preheat to start immediately at the default temperature.

1. Press **PREHEAT**

If needed, use numeric keypads to enter a different oven temperature.

2. Press **START**

"**PRE**" and the actual oven temperature shown in the display will alternate as the oven heats and reaches set temperature.

When the oven is finished preheating, the controls will beep to remind you to place food in the oven. The preheat feature will perform like the Bake feature and continue to maintain the oven set temperature until cancelled.

## NOTE

- To cancel the function, you may press **STOP** at any time when setting the control or during the cooking process.
- To change the set temperature while the oven is already heating, follow the same procedure described above.

## Bake

Use the bake feature to cook most food items that require normal cooking temperatures.

The following temperature settings apply to the bake feature:

- Auto-suggest (default) setting: **350°F/177°C**
- Min. bake setting: **170°F / 77°C**
- Max. bake setting: **550°F / 288°C**

## Setting bake

See example below to set a bake to start immediately at the default temperature.

1. Press **BAKE**

If needed, use numeric keypads to enter a different oven temperature.

2. Press **START**

Once **START** is pressed the oven will begin heating. The oven display shows the temperature rising.

After the oven reaches set temperature a beep will indicate the oven is ready. The oven will continue to maintain this temperature until the cooking feature is canceled.

## NOTE

To cancel the function, you may press **STOP** at any time when setting the control or during the cooking process.

To change the set temperature while the oven is already heating, follow the same procedure described above.

## For best results

- As much as possible, use only one rack on position 2 or 3 and center the pans. If using two racks, place the oven racks in position 2 and 4.
- When placing multiple food items in the oven allow 2-4" (5-10cm) of space between the food items for proper air circulation.
- Dark or dull pans absorb more heat than shiny bakeware resulting in dark or overbrowning of foods. It may be necessary to reduce the oven temperature or cook time to prevent overbrowning of some foods. Dark pans are recommended for pies. Shiny pans are recommended for cakes, cookies and muffins.

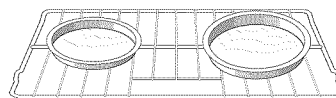

Pan position for one rack baking.

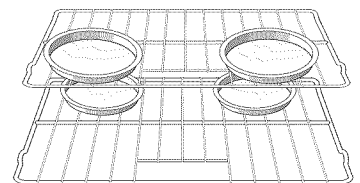

Pan position for two rack baking.

# Setting Oven Controls

## Cook Time

Adding a cook duration when baking is beneficial when a recipe requires a specific temperature and period of time to cook. Following the recipe cook time helps insure the best possible results.

Cook time may be set with the following features:

- Preheat
- Bake
- Conv Bake
- Conv Roast
- Slow Cook

See example below to set the oven for bake, starting immediately with preheating to the auto-suggest (default) setting of 350°F (177°C) and then to automatically turn off after 30 minutes:

1. Press **BAKE**
2. Press **START**
3. Press **COOK TIME**
4. Enter **30** minutes
5. Press **START**

Once **START** is pressed the oven will cook and after 30 minutes automatically shut-off.

### When the Cook Time finishes:

1. "**End**" and the time of day will show in display. The oven will shut off automatically.
2. The control will beep 3 times. The control will continue to beep 3 times every 30 seconds until **STOP** is pressed.

### NOTE

- To cancel the function, you may press **STOP** at any time when setting the control or during the cooking process.
- The maximum Cook Time setting is 11 hours and 59 minutes.
- After the Cook Time feature has been activated, the display will go back to showing the hour of day. Press the **COOK TIME** keypad to display any remaining cook time.
- Dark or dull pans absorb more heat than shiny bakeware resulting in dark or overbrowning of foods. It may be necessary to reduce the oven temperature or cook time to prevent overbrowning of some foods. Dark pans are recommended for pies. Shiny pans are recommended for cakes, cookies or muffins.

## Delay Start (with cook time)

Adding a cook duration along with a specific start time gives the same benefits as the cook time option in addition to controlling exactly when the cooking process will begin and end.

Delay start may be set with the following features:

- Bake
- Conv Bake
- Conv Roast
- Slow Cook
- Flex Clean

See example below to set the oven with preheating for bake at 375°F (191°C) for 50 minutes and to automatically start at 5:30:

1. Press **BAKE**
2. Enter **375°F**
3. Press **START**
4. Press **COOK TIME**
5. Enter **50** minutes
6. Press **START**
7. Press **DELAY START**
8. Enter **5:30**
9. Press **START**

Once **START** is pressed, the oven will calculate the start time at which the oven will begin heating.

The oven will continue to maintain this temperature for the selected time or until the cooking feature is canceled.

### NOTE

- When setting the **DELAY START** option be sure the correct time of day is set.
- You may press **STOP** any time when setting the control or during the cooking process.
- You may also choose to use **DELAY START** with no **COOK TIME**.
- Delay Start may be set using a 24 hour clock. See Setting 12 or 24 hour display modes for more information.

## WARNING

**FOOD POISONING HAZARD.** Do not let food sit for more than one hour before or after cooking. Doing so can result in food poisoning or sickness. Foods that can easily spoil such as milk, eggs, fish, meat or poultry, should be chilled in the refrigerator first. Even when chilled, they should not stand in the oven for more than 1 hour before cooking begins, and should be removed promptly when finished cooking.

# Setting Oven Controls

## Convection Bake

Convection Bake uses a fan to circulate the oven heat evenly and continuously. The improved heat distribution allows for even cooking with excellent results. Multiple rack cooking may slightly increase cook times for some foods, but the overall result is time saved.

The Conv Bake feature should **ONLY** be used when your recipe instructions have been written for use with convection baking.

If your recipe instructions are for normal baking and you wish to use convection bake, follow the **Convection Convert** option instructions. The convection convert option will automatically adjust the oven temperature so that convection baking may provide the best possible results.

Conv Bake may be set with the following options:

- Conv Convert
- Cook Time and/or Delay Start

### Benefits of convection bake:

- Superior multiple oven rack performance.
- Some foods cook up 25 to 30% faster, saving time and energy.
- No special pans or bakeware required.

### For best results

- When baking with a single rack use rack positions 2 or 3. When using 2 racks use rack positions 2 & 4. When using 3 racks use rack positions 1, 3 & 4.
- Cookies and biscuits should be baked on pans with no sides or very low side to allow heated air to circulate around the food.
- Food baked on pans with a dark finish will cook faster.
- When placing multiple food items in the oven allow 2-4" (5-10cm) of space between the food items for proper air circulation.

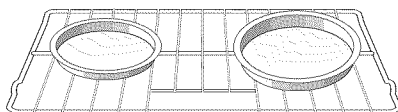

Pan position for one rack baking.

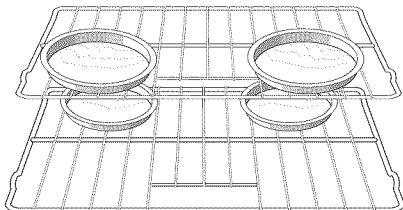

Pan position for two rack baking.

The following temperature settings apply to the conv bake feature:

- Auto-suggest (default) setting: **350°F / 177°C**
- Min. bake setting : **300°F / 149°C**
- Max. bake setting: **550°F / 288°C**

See the example below to set conv bake, starting immediately with the default setting of 350°F (177°C):

1. Press **CONV BAKE**

If needed, use numeric keypads to enter a different oven temperature.

2. Press **START**

After the oven reaches set temperature, a beep will indicate the oven is ready. The oven will continue to maintain this temperature until the cooking feature is canceled.

### NOTE

You may press **STOP** any time when setting the control or during the cooking process.

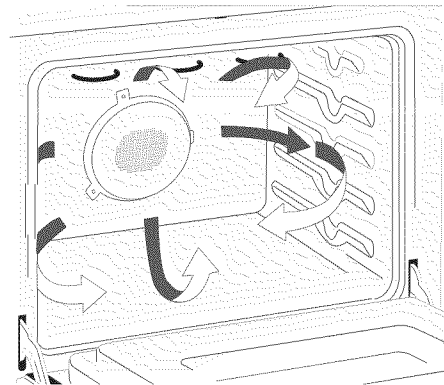

Convection air flow

### NOTE

- The convection fan will begin rotating 6 minutes after Conv Bake, Conv Roast or Conv Convert has been activated.
- If the oven door is opened when any convection function is active and the convection fan is rotating, the convection fan will stop rotating until the oven door is closed.



# Setting Oven Controls

## Convection Convert

The conv convert option allows you to convert any normal baking recipe using the convection bake feature. The control uses the normal recipe settings and adjusts to a lower temperature for convection baking. Conv convert must be used with Conv Bake feature.

### Benefits of conv bake using conv convert option:

- Superior multiple oven rack performance.
- Some foods cook up 25 to 30% faster, saving time and energy.
- No special pans or bakeware required.

### For best results

- Place food items using the recommended rack positions. When baking with a single rack use rack positions 2 or 3. When using 2 racks use rack positions 2 & 4. When using 3 racks use rack positions 1, 3 & 4.
- Cookies and biscuits should be baked on pans with no sides or very low side to allow heated air to circulate around the food.
- Food baked on pans with a dark finish will cook faster.
- When placing multiple food items in the oven allow 2-4" (5-10cm) of space between the food items for proper air circulation.

See the example below to set conv bake, starting immediately with the auto-suggest (default) setting of 350°F (177°C) and adding the conv convert option.

1. Press **CONV BAKE**

If needed, use numeric keypads to enter a different oven temperature.

2. Press **CONV CONVERT**

3. Press **START**

After the oven reaches the converted set temperature, a beep will indicate the oven is ready.

The added conv convert option will automatically **lower** the set temperature you set from the bake recipe to an adjusted conv bake temperature.

When conv convert is used with cook time "**CF**" (Check Food) will be displayed when the cook time is 75% complete. The control will also beep at regular intervals until baking has finished. For the Check Food function to operate, the cook time must be entered before the Conv Convert pad is pressed.

### NOTE

You may press **STOP** any time when setting the control or during the cooking process.

# Setting Oven Controls

## Convection Roast

Convection roast combines a cook cycle with the convection fan and element to rapidly roast meats and poultry. Heated air circulates around the meat from all sides, sealing in juices and flavors. Meats cooked with this feature are crispy brown on the outside while staying moist on the inside. In addition, there is no need to reduce the oven temperature when using convection roast.

Convection roast may be set with the following options:

- Cook time or cook time with delay start

The following temperature settings apply to convection roast:

- Factory auto-start default: **350°F/177°C**
- Minimum: **300°F / 149°C**
- Maximum: **550°F / 288°C**

### Benefits of convection roast:

- Superior multiple oven rack performance.
- Some foods cook up 25 to 30% faster, saving time and energy.
- No special pans or bakeware required.

### For best results

- Preheating is not necessary for most meats and poultry.
- Be sure to carefully follow your recipe's temperature and time recommendations or refer to the convection roast chart for additional information.
- Do not cover foods when dry roasting - this will prevent the meat from browning properly.
- Since Conv Roast cooks food faster, reduce the cook time by 25% from the recommended cook time of your recipe (check the food at this time). If necessary, increase cook time until the desired doneness is obtained.

See example below to set convection roast to start immediately with the auto-suggest (default) setting:

1. Press **CONV ROAST**
2. Press **START**

Once START is pressed the oven will begin heating.

### NOTE

- You may press **STOP** any time when setting the control or during the cooking process.
- The convection fan will begin rotating 6 minutes after Conv Bake, Conv Roast or Conv Convert has been activated.
- If the oven door is opened when any convection function is active and the convection fan is rotating, the convection fan will stop rotating until the oven door is closed.

### Roasting rack instructions

The broil pan, its insert and the roasting rack are available via the mail order card. When preparing meats for convection roasting, you may use the broiler pan, insert and the roasting rack supplied with your appliance. The broiler pan will catch grease spills and the insert will help prevent grease splatters. The roasting rack fits on top of the insert allowing the heated air to circulate under the food for even cooking and helps to increase browning on the underside.

1. Place oven rack on bottom or next to the bottom oven rack position.
2. Place the insert on the broiler pan.
3. Make sure the roasting rack is securely seated on top of the insert. **Do not** use the broiler pan without the insert. **Do not** cover the insert with aluminum foil.
4. Position food (fat side up) on the roasting rack. -Fig. 1-
5. Place prepared food on oven rack in the oven.

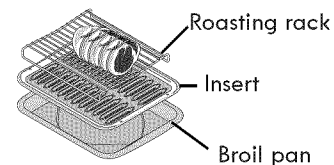

Meat		Weight	Oven temp	Internal temp	Minute per lb.
Beef	Standing rib roast	4 to 6 lbs.	350°F	*	25-30
	Rib eye roast	4 to 6 lbs.	350°F	*	25-30
	Tenderloin roast	2 to 3 lbs.	400°F	*	15-25
Poultry	Turkey, whole**	12 to 16 lbs.	325°F	180°F	8-10
	Turkey, whole**	16 to 20 lbs.	325°F	180°F	10-15
	Turkey, whole**	20 to 24 lbs.	325°F	180°F	12-16
	Chicken	3 to 4 lbs.	350°F - 375°F	180°F	12-16
Pork	Ham roast, fresh	4 to 6 lbs.	325°F	160°F	30-40
	Shoulder blade roast	4 to 6 lbs.	325°F	160°F	20-30
	Loin	3 to 4 lbs.	325°F	160°F	20-25
	Pre-cooked ham	5 to 7 lbs.	325°F	160°F	30-40

\* For beef: med rare 145°F, med 160°F, well done 170°F

\*\* Stuffed turkey requires additional roasting time. Shield legs and breast with foil to prevent overbrowning and drying of the skin.

# Setting Oven Controls

## Broil

Use the **broil** feature to cook meats that require direct exposure to radiant heat for optimum browning results.

The following temperature settings apply to the broil feature:

- Auto-suggest (default) setting: **550°F / 288°C**
- Min. broil setting: **400°F / 204°C**
- Max. broil setting: **550°F / 288°C**

## Setting Broil

See example below to set broil starting immediately with the auto-suggest (default) setting:

1. Place the broiler insert on the broiler pan, then place the meat on the insert. Remember to follow all warnings and cautions.
2. Arrange the interior oven rack to rack position recommendations. Be sure to place the prepared food and pan directly under broil unit. **Close the door.**
3. Press **BROIL**
4. Press **START**

## NOTE

You may press **STOP** any time when setting the control or during the cooking process.

Be aware that the suggested broil settings table are recommendations only. Increase or decrease broiling times, or move to a different rack position to suit for doneness. If the food you are broiling is not listed in the table, follow the instructions provided in your cookbook and watch the item closely.

## For best results

- Use the recommended pans and oven rack positions for the type of meat being prepared.
- For optimum browning results, allow the oven to preheat **2 minutes** before placing the food in the oven.

## CAUTION

- **Do not** use the broiler pan without the insert.
- **Do not** cover the broil pan/insert with aluminum foil; the exposed grease could ignite.
- To prevent food from contacting the broil unit and to prevent grease splattering, **do not** use the roasting rack when broiling.

## WARNING

Should an oven fire occur, close the oven door. If the fire continues, throw baking soda on the fire or use a fire extinguisher. **Do not** put water or flour on the fire. Flour may be explosive and water can cause a grease fire to spread and cause personal injury.

The broil pan and its insert are available via the mail order card. The broil pan insert contains slots that allows grease from the meat to drain into the broil pan. Place prepared meat on broil pan insert and then place onto broiler pan as shown below.

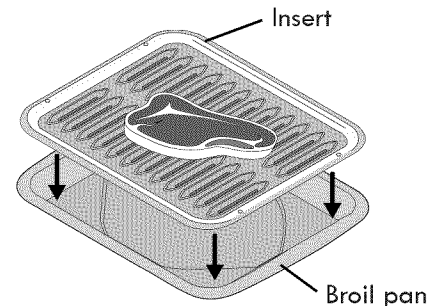

Food	Rack position	Temp	Cook time in minutes		Doneness
			1st side	2nd side	
Steak 1" thick	3rd or 4th	550°F	6	4	Rare
	3rd or 4th	550°F	7	5	Medium
	3rd or 4th	550°F	8	7	Well
Pork chops 3/4" thick	3rd or 4th	550°F	8	6	Well
Chicken-bone in	3rd	450°F	20	10	Well
Chicken-boneless	3rd or 4th	450°F	8	6	Well
Fish	3rd	500°F	13	0	Well
Shrimp	3rd	550°F	5	0	Well
Hamburger 1" thick	3rd or 4th	550°F	9	7	Medium
	3rd or 4th	550°F	10	8	Well

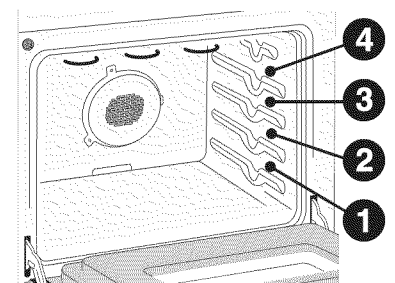

Rack positions

# Setting Oven Controls

## Cakes Breads

The Cakes Breads functions are designed to give optimum baking performance for Cakes or Breads. These functions work well for baking cakes, brownies, pies (fresh or frozen), baked custards, cheesecakes, breads, rolls, biscuits, muffins and cornbread.

The Cakes function provides a preheat with a gentle cycling of heat giving cakes more volume and allowing delicate foods to cook more evenly.

The Breads function adds a special preheat feature to the bake cycle that thoroughly heats the oven from top to bottom to give more evenly browned foods.

See the example below to set Cakes or Breads.

1. Arrange oven racks when cool. If needed preheat oven as desired and place food in oven.
  2. For Cakes, press the **CAKES BREADS** keypad until **CAKES** appears in the oven display.  
For Breads, press the **CAKES BREADS** keypad until **BREADS** appears in the oven display.
- If needed, use numeric keypads to enter a different oven temperature.
3. Press **START**.

### NOTE

You may press **STOP** any time when setting the control or during the cooking process.

### For best results

- Dark or dull pans absorb more heat than shiny bakeware resulting in dark or overbrowning of foods. It may be necessary to reduce the oven temperature or cook time to prevent overbrowning of some foods. Dark pans are recommended for pies. Shiny pans are recommended for cakes, cookies or muffins.
- Breads will have better results baking on a single oven rack.
- When baking layer cakes or cookies using 2 oven racks, place cookware on rack in position 2 and 4. For best results when baking cakes or cookies using a single oven rack, place rack in position 2 or 3.

## Warm & Hold™

The Warm & Hold feature will keep oven baked foods warm for serving up to 3 hours after cooking has finished. After 3 hours the Warm & Hold feature will shut-off automatically. The Warm & Hold should only be used with foods that are already at serving temperature. The Warm & Hold feature will maintain an oven temperature of 170°F (77°C).

The Warm & Hold feature may be used without any other cooking operations or may be used after cooking has finished using Cook Time or Delay Start.

See example below to set Warm & Hold for the oven to start immediately.

1. Press **WARM & HOLD**
2. Press **START**

See example below to set Warm & Hold to start after a Cook Time or Delay Start.

1. Press **BAKE** or any other cooking function.

If needed, enter a different temperature.

2. Press **START**.
3. Press **BAKE TIME**.
4. Enter time.
5. Press **START**.

If needed, set a **DELAY START** feature.

6. Press **WARM & HOLD**.
7. Press **START**

### NOTE

You may press **STOP** any time when setting the control or during the cooking process.

# Setting Oven Controls

## Meat Probe

When cooking meat such as roasts, hams or poultry you can use the probe to check the internal temperature without any guesswork. For some foods, especially poultry and roasts, testing the internal temperature is the most effective way of insuring that your food has been properly cooked.

Your oven will automatically change from cooking to keep warm once the probe has reached the set temperature.

The following temperature settings apply to the probe function:

- Default: **170°F / 76°C**
- Minimum: **130°F / 54°C**
- Maximum: **210°F / 99°C**

### IMPORTANT

- Use only the probe supplied with your appliance; any other may result in damage to the probe or the appliance.
- Be sure the probe is **fully** inserted into the probe receptacle. The probe will not work properly until correctly connected.
- Handle the probe carefully when inserting and removing it from the food and the receptacle.
- Do not use tongs to pull the cable when inserting or removing it from the food or the receptacle.
- Defrost your food completely before inserting the probe to avoid damaging probe.
- **Never leave or store the probe inside the oven when not in use.**
- To prevent the possibility of burns, carefully unplug the probe using a pot holder.

### Proper probe placement

- Always insert the probe so that the tip rests in the center of the thickest part of the meat. Do not allow the probe to touch bone, fat, gristle or the pan.
- For bone-in ham or lamb, insert the probe into the center of the lowest large muscle or joint. For dishes such as meat loaf or casseroles, insert the probe into the center of the food. To find the center of the food visually measure with the probe -Fig. 1-. When cooking fish, insert the probe just above the gill.
- For whole poultry or turkey, insert the probe into the thickest part of the inner thigh, below the leg -Fig. 2-.

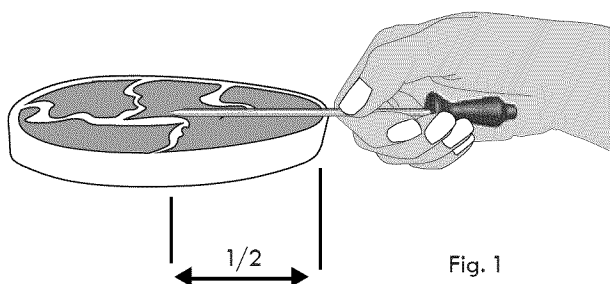

Fig. 1

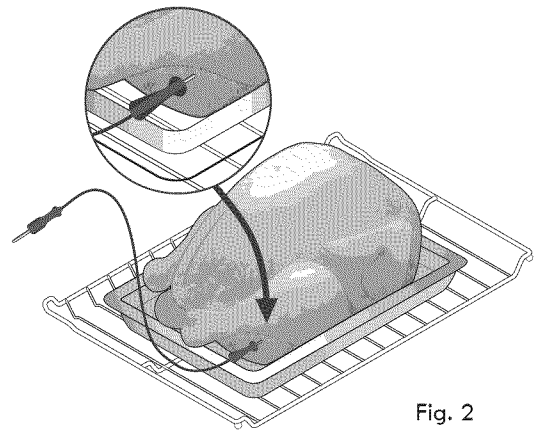

Fig. 2

### Important note:

Changing how the oven reacts after reaching the target temperature must be done before starting the cooking process.

### To Set Meat Probe:

1. Prepare the food and properly insert the temperature probe into the food. **DO NOT** preheat or start cooking before properly inserting the meat probe. The probe should be inserted into the food and receptacle while the oven is still cool.
2. Place the prepared food on the desired oven rack position and slide into the oven.
3. Plug the meat probe into the probe receptacle located on the left front oven cavity top (See Fig. 3 for location of probe receptacle).

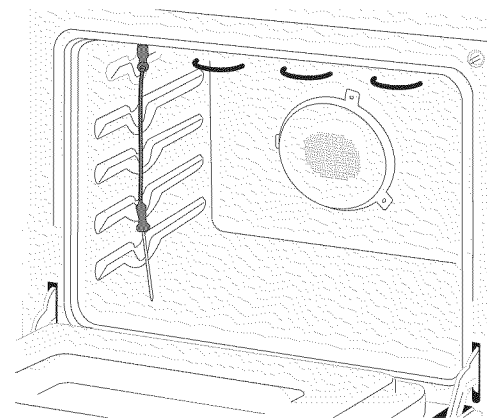

Fig. 3

4. The oven control detects if the meat probe is correctly plugged in to receptacle and when recognized will illuminate the probe icon in the oven control display.
5. To set the target temperature press **MEAT PROBE** keypad once then enter the desired target internal temperature using the numeric key pads (default setting is 170°F/77°C)†. Press **START** to accept the meat probe target temperature. Close the oven door.

# Setting Oven Controls

## Meat Probe (cont'd)

### To Set Meat Probe:

6. Set the oven control for Bake, Conv Bake or Conv Roast and the desired oven temperature. You may use the meat probe with some other baking features, but the meat probe cannot be set with Broil or Flex-Clean.
7. During the cooking process the actual meat probe temperature will display by default. To view the target temperature press the Meat Probe keypad once. After 6 seconds the display will show the actual meat probe temperature. If the target temperature needs to be changed during the cooking process, press the Meat Probe keypad once and use the numeric keypads to adjust the target temperature. Press the **START** key to accept any change.
8. The oven control will provide 3 beeps when the internal target temperature is reached. By default the oven will automatically change to a Warm & Hold setting. The Warm & Hold function will maintain the oven temperature at 170°F (77°C). Instructions for changing how the oven reacts after reaching the internal target temperature may be found later in this section. Press **STOP** to cancel cooking at any time.

See the following instructions for changing how the oven reacts after reaching the internal target temperature.

### To set the oven to continue cooking after reaching the probe target temperature:

1. Press **MEAT PROBE** keypad and hold for 6 seconds.
2. Press **FLEX CLEAN** keypad and toggle until the "Continu" message appears (Fig. 1) then press **START** to accept.

### To set the oven to cancel cooking and automatically start Warm & Hold after reaching the probe target temperature:

1. Press **MEAT PROBE** keypad and hold for 6 seconds.
2. Press **FLEX CLEAN** keypad and toggle until the "CAnCEL" message appears (Fig. 2) then press **START** to accept.



Fig. 1



Fig. 2

† The U.S. Department of Agriculture states, "Rare fresh beef is popular, but you should know that cooking it to only 140°F/60°C means some food poisoning organisms may survive." (Source: Safe Food Book, Your Kitchen Guide, USDA Rev. June 1958.)

The lowest temperature recommended by the USDA is 145°F/63°C for medium rare fresh beef.

# Setting Oven Controls

## Slow Cook

The Slow Cook feature may be used to cook foods more slowly at lower oven temperatures. Slow Cook provides cooking results much the same way as a slow cooker or Crock-Pot.

This feature is ideal for roasting beef, pork & poultry. Slow cooking meats may result in the exterior of meats becoming dark but not burnt; this is normal.

Slow Cook may be set with the following options:

- Cook Time
- Cook Time and/or Delay Start

For Slow Cook two settings are available, high (**Hi**) or low (**Lo**). The high setting is best for cooking foods from a 4 to 5 hour time period. The low setting is best for cooking foods from a 8 to 9 hour time period.

See the example below to set a slow cook.

1. Press **SLOW COOK** to choose the Hi option -Fig. 1-
2. Press **SLOW COOK** again to choose the Lo option -Fig. 2-
3. Press **START**



Fig.1

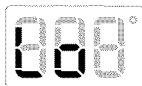

Fig. 2

### NOTE

You may press **STOP** any time when setting the control or during the cooking process.

### For best results

- Completely thaw all frozen foods before cooking.
- Position multiple racks to accommodate size of cooking utensils when cooking multiple food item.
- Add any cream or cheese sauces during the last hour of cooking.
- Do not open the oven door often or leave the door open when checking foods. The more heat that is lost, the longer the food will need to cook.
- Cover the foods to keep them moist or use a loose or vented type cover to allow foods to turn crisp or brown.
- Roasts may be left uncovered so browning can occur. Cook times will vary depending on the weight, fat content, bone & the shape of the roast.
- Preheating the oven will not be necessary.
- Use the recipe's recommended food temperature and a food thermometer to determine when the food is done.

## Recipe Recall

The Recipe Recall feature may be used to record and recall your favorite recipe settings. This feature may store 1 setting for each of the basic cooking pads. The keypads that a recipe may be stored with are **Bake, Conv Bake, Conv Roast, Cakes Breads, Preheat** and **Slow Cook**. This feature will also store and recall Cook Time or Warm & Hold added settings.

See example below to store a typical cookie recipe (example for baking at 375°F for 9 minutes and to shut-off automatically).

Preheat\* the oven to the desired temperature.

1. Press **BAKE**.
2. Press **3 7 5**.
3. Press **START**.
4. Press **COOK TIME**.
5. Enter the desired baking time. Press **9**.
- 6 Press and hold **START** until acceptance tone sounds (about 3 seconds).

This recipe is now stored with the **Bake** key pad.

### NOTE

Pressing the **START** pad after entering cooking temperatures and times will start the oven. If you wish to store the recipes but not start the oven press **STOP** after pressing the **START** pad.

\* The **Cook Time** you enter does NOT include additional time required to **Preheat** the oven. The oven will begin to count down the cooking time as soon as the feature is activated.

See example below to recall a previously stored recipe under **BAKE** pad.

1. Press **BAKE**. The stored recipe is recalled.
2. Press **START**.

### NOTE

- Once a recipe has been stored with a keypad, the recipe information will be recalled when pressing the corresponding keypad in the future.
- If a recalled recipe includes Cook Time, the oven will automatically shut-off when the Cook Time is finished.
- To erase all recipes stored, see section for Restoring factory default settings.

# Setting Oven Controls

## Sabbath Mode

This appliance provides special settings for use when observing the Jewish Sabbath/Holidays. This mode will turn off all audible tones or visual display changes normally provided by the oven control. **BAKE** is the only cooking features available while in the Sabbath mode.

You must first set the **BAKE** feature and the temperature(s) needed, the **COOK TIME** option if needed before setting the Sabbath mode. Any settings made prior to setting the Sabbath mode will be visible in the displays.

The Sabbath mode will override the factory preset 12 Hour Energy Saving mode and the appliance will stay on until the cooking features are cancelled. If any of the cooking features are cancelled when the appliance is in the Sabbath mode, no audible or visual indicators will be available to verify the cancellation.

If the oven interior lights are needed, be sure to activate them prior to setting the Sabbath mode. Once the oven light is turned ON and the Sabbath mode is active, the oven light will remain on until the Sabbath mode is turned off and the oven lights are turned off. The oven door will not activate the oven interior lights when the oven door is opened or closed.

It is recommended that any oven temperature modification made within an active Sabbath mode be followed with 2 presses of the **START** key. This will insure the oven remains ON even if an attempt is made to set the oven temperature outside of its temperature range. If the oven temperature is set outside of the temperature range, the oven will default to the nearest available temperature. Try to set the desired oven temperature again.

Should a power failure or interruption occur during the Sabbath/Holidays, the appliance will shut OFF. When power is restored the appliance will not turn back on automatically to the original **BAKE** feature settings. **SF** will appear in all the control display panels indicating a Sabbath mode failure. After a power failure, the food may be safely removed from the oven while still in the Sabbath mode.



For further assistance, guidelines for proper usage and a complete list of models with the Sabbath feature, please visit the web at <http://www.star-k.org>.

## Setting Sabbath Mode

The example below shows setting the oven to observe the Sabbath (and Jewish holidays).

1. Press **BAKE**.
2. Press **START**

Be sure to make any additional oven setting changes (Oven Light, Cook Time and/or Delay Start, Warm & Hold) before going to step 3.

3. To enter Sabbath mode, press and hold **simultaneously** both the **COOK TIME** and **DELAY START** keys together for 3 seconds (a beep will sound) and release.

Once properly set in Sabbath mode, SAb will show in the oven display until the Sabbath mode is cancelled.

### NOTE

You may press **STOP** any time when setting the control or during the cooking process.

## Cancelling Sabbath mode

The example below shows how to cancel the Sabbath mode.

1. Press and hold both the **COOK TIME** and **DELAY START** keys together for 3 seconds (a beep will sound) and release.
2. All cooking features previously set will automatically cancel once Sabbath mode has ended.

### NOTE

The only keys available once the appliance is set for the Sabbath mode are **BAKE**, **START**, **STOP** and the **numeric pads**.

You may change the oven temperature once baking has started (Jewish holidays only). Press **BAKE**, enter the oven temperature using the numeric keys and press **START twice**. Remember that **the oven control will no longer beep or display any further changes** once the oven is set in the Sabbath mode.



# User Preferences

## Setting Clock

See the example below to set the clock to 1:30.

1. Press .
2. Enter **1:30** to advance to 1:30.
3. Press **START** to accept or press **STOP** to reject.

## Setting 12 or 24 Hour Mode

The clock display mode allows you to choose between 12 and 24 hour mode. The factory preset clock display mode is 12 hour.

See the example below to change the default mode to 24 hour.

1. Press and hold  for 7 seconds until "12Hr dAy" or "24Hr dAy" appear in the display.
2. Press **FLEX CLEAN** to switch between the 12 and 24 hour mode.
3. Press **START** to accept or press **STOP** to reject.

## Adjusting Oven Temperature User preference offset

Your appliance has been factory calibrated and tested to ensure an accurate baking temperature. For the first few uses, follow your recipe times and temperature recommendations carefully.

If you feel your oven is too hot or too cool from your baking experience, the oven temperature may be adjusted to your liking. The temperature may be increased up to +35°F (+19°C) or decreased down to -35°F (-19°C) from normal.

See the example below to increase the temperature.

1. Press and hold **BAKE** for 7 seconds until UPO appear in the display.
2. Enter the desired temperature change using the number pads. **FLEX CLEAN** can be pressed to lower the temperature.
3. Press **START** to accept or press **STOP** to reject.

## Setting Silent Control Operation

The silent control operation allows you to control the audio for the oven control. You may turn the audio off and later return to operating with all the normal audible sounds and alerts.

See the example below when changing the audible settings.

1. Press and hold **DELAY START** for 7 seconds until BEEP appears in the display.
2. Press **FLEX CLEAN** to switch between the On and Off mode.
3. Press **START** to accept or press **STOP** to reject.

## Changing Between F° or C°

Your control has the ability to display and set Fahrenheit or Celsius temperatures. The factory preset temperature display is Fahrenheit.

See the example below to change the default temperature display to Celsius.

1. Press and hold **BROIL** for 7 seconds until F or C appear in the display.
2. Press **FLEX CLEAN** to switch between the F and C mode.
3. Press **START** to accept or press **STOP** to reject.

## Setting 12hr Energy Saving Mode

The oven control has a factory preset built-in 12 hour energy saving feature that will shut off the appliance if the oven has been heating for more than 11 hours and 59 minutes. The oven can be programmed to override this feature for continuous baking.

See the example below to turn off 12 hour energy saving mode.

1. Press and hold **TIMER** for 7 seconds until "12Hr OFF" or "StAy On" appear in the display.
2. Press **FLEX CLEAN** to switch between the "12Hr OFF" or "StAy On" mode.
3. Press **START** to accept or press **STOP** to reject.

## Restoring Factory Default Settings

When new, your appliance was set with predetermined oven control settings. Over time, the user may make changes to these default settings. The following features or functions have user options or adjustments that may have been changed from the factory default settings:

- 12 or 24 hour display mode
- Continuous bake or 12-Hour Energy Savings mode
- Silent or audible control
- Oven temperature display (Fahrenheit or Celsius)
- Oven temperature adjustments
- All stored recipes

Please be aware before restoring to factory default settings that ALL of the above user settings will be restored, including any oven temperature offset and any stored recipe information.

1. Press and hold the **7** numeric keypad until acceptance tone sounds (about 6 seconds).
2. Press **START**. The control will reset all user preference settings back to factory default settings.

# Self-Cleaning Cycle

## Before Starting Self-Clean

A self-cleaning oven cleans itself with high temperatures that are well above those used for normal cooking. The high cleaning temperature eliminates soils completely or reduces them to a fine powdered ash that you can later easily wipe away with a damp cloth.

Adhere to the following precautions when running the self-clean cycle:

- Allow the oven to cool before cleaning.
- Wear rubber gloves when cleaning any exterior parts of the oven manually.
- **Do not** use oven cleaners or protective coatings in or around the oven interior.
- **Do not** clean the oven door gasket. The woven material of the oven door gasket is essential for a good seal. Care should be taken not to rub, damage or remove the gasket. -Fig. 1-
- **Do not** use any cleaning materials on the door gasket. Leaving chemical residue can damage the door gasket.
- **Do not** force the oven door open. The automatic door locking system can be damaged.
- **Remove all utensils and any aluminum foil from the oven.** These items cannot withstand high cleaning temperatures.
- This oven comes with lubricated porcelain oven racks, which can remain in the oven during the self-clean cycle. Do not clean this vegetable oil lubrication off the racks. It is important that the sides of the oven racks always have a light coating of vegetable oil. To maintain optimal rack performance, re-apply a thin layer of vegetable oil to the sides of the rack after every self-clean cycle or when the rack becomes difficult to slide.
- **Remove any excessive spillovers** in the oven cavity **before** starting a self-clean cycle. To clean, use hot, soapy water and a cloth. Large spillovers can cause heavy smoke or fire when subjected to high temperatures.
- Clean any soil from the oven frame, the door liner outside the oven door gasket and the small area at the front center of the oven bottom with soap and water. These areas heat sufficiently to burn soil on.
- **Do not** allow food spills with a high sugar or acid content (such as milk, tomatoes, sauerkraut, fruit juices or pie filling) to remain on the porcelain surface, they may leave a dull spot even after cleaning.

## ⚠ WARNING

During the self-clean cycle, the outside of the appliance can become very hot to the touch. **DO NOT** leave small children unattended near the appliance.

## ⚠ CAUTION

- **DO NOT** line the oven walls, oven racks, bottom or any other part of the appliance with aluminum foil. Doing so will stop heat distribution, produce poor baking results and cause permanent damage to the oven interior (aluminum foil will melt to the interior surface of the oven).
- **DO NOT** force the oven door open. This can damage the automatic door locking system. Use caution when opening the door after the self-clean cycle is finished. The oven may still be **VERY HOT**.
- The health of some birds is extremely sensitive to the fumes given off during the self-cleaning cycle of any appliance. Move birds to another well-ventilated room.

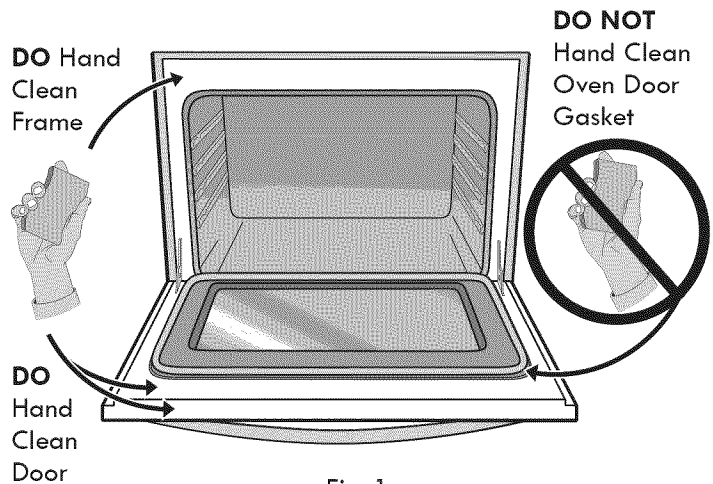

Fig. 1

## What to Expect during Cleaning

While the oven is in operation, the oven heats to temperatures much higher than those used in normal cooking. Sounds of metal expansion and contraction are normal. Odor is also normal as the food soil is being removed. Smoke may appear through the oven vent.

If heavy spillovers are not wiped up before cleaning, they may flame and cause more smoke and odor than usual. This is normal and safe and should not cause alarm. If available, use an exhaust fan during the self-cleaning cycle.

# Self-Cleaning Cycle

## Flex Clean Cycle

The **FLEX CLEAN** pad controls the Self-Cleaning feature. When used with a the Delay Start pad, a delayed Self-Cleaning cycle may also be programmed. The Flex Clean feature allows for any Self-Cleaning cycle time from 2 (2:00) to 4 hours (4:00). You may also choose the clean time in 1 minute increments (for example 2 hours and 50 minutes) by pressing the corresponding number keypads.

If you are planning to use the oven directly after a self-clean cycle remember to allow time for the oven to cool down and the oven door to unlock. This normally takes about one hour. So a 3 hour self-clean cycle will actually take about 4 hours to complete.

\*It is recommend to use a 2 hour self-clean cycle for **light soils**, a 3 hour cycle for **average soils**, and a 4 hour cycle for **heavy soils** (to assure satisfactory results).

**NOTE:** The kitchen area should be well ventilated using an open window, ventilation fan or exhaust hood during the Self-Clean cycle. This will help eliminate the normal odors associated with the Self-Clean cycle.

See example below to start an immediate Self-Cleaning cycle or to set a Delay Start time of 9:00 o'clock and shut-off automatically (example provided is a default 3 hour Self-Clean cycle)

1. Be sure the clock is set with the correct time of day, the oven is **EMPTY** and the oven door is closed.
2. Press **FLEX CLEAN**.

The control will automatically clean for a 3 hour period (default self-cleaning cycle time). Note: If a 2 or 4 hour clean time is desired, press **2 0 0** for 2 hour or press **4 0 0** for a 4 hour clean time. Set the cleaning time based on the amount of soil: light, medium or heavy (\*See above).

3. Press **START**.

As soon as the control is set, the motor driven oven door lock will begin to close automatically. Once the door has been locked the "**DOOR LOCKED**" indicator light will stop flashing and remain on.

**Note:** Allow about 15 seconds for the oven door lock to close.

**Note: If the optional delay Self-Clean feature is needed, finish steps 4-6.**

4. Press **DELAY START**.
5. Enter the desired Self-Clean starting time using the number pads **9 0 0**.
6. Press **START**.

The control will calculate forward from the set start time to determine when the Self-Cleaning cycle should end. The Self-Cleaning cycle will turn on automatically at the set time.

## CAUTION

- To avoid possible burns use care when opening the oven door after the Self-Cleaning cycle. Stand to the side of the oven when opening the door to allow hot air or steam to escape.
- **DO NOT** force the oven door open. This can damage the automatic door locking system. Use caution and avoid possible burns when opening the door after the Self-Cleaning cycle has completed. The oven may still be **VERY HOT**.

## When the Self-Clean Cycle is Completed

Once the oven has cooled down for approximately 1 HOUR, and the "**DOOR LOCKED**" icon is no longer displayed, the oven door can then be opened.

## Stopping or Interrupting a Self-Cleaning Cycle

If it becomes necessary to stop or interrupt a self-cleaning cycle due to excessive smoke or fire in the oven:

1. Press **STOP**.
2. Once the oven has cooled down for approximately 1 HOUR, and the "**DOOR LOCKED**" icon is no longer displayed, the oven door can then be opened.

## NOTE

A smoke eliminator in the oven vent converts most of the smoke into a colorless vapor.

## IMPORTANT

If a self-clean cycle was started but did not finish due to a power failure, your oven may not be completely cleaned. After power has been restored and the oven door has unlocked, set for another self-clean if needed.

# Care & Cleaning

Before cleaning any part of the oven, be sure all controls are turned OFF and the oven is COOL. REMOVE SPILLOVERS AND HEAVY SOILING AS SOON AS POSSIBLE. REGULAR CLEANINGS NOW WILL REDUCE THE EXTENT AND DIFFICULTY OF MAJOR CLEANING LATER.

Surface Type	Cleaning Recommendation
Painted body parts, Painted decorative trim Aluminum, plastic or vinyl trim Control knobs (some models)	For general cleaning, use hot, soapy water and a cloth. For more difficult soils and built-up grease, apply a liquid detergent directly onto the soil. Leave on soil for 30 to 60 minutes. Rinse with a damp cloth and dry. <b>Do not</b> use abrasive cleaners on any of these materials; they can scratch. To remove control knobs, turn to the OFF position; grasp firmly and pull straight off the shaft. To replace knobs after cleaning, line up the flat sides of both the knob and the shaft; then push the knob into place.
Control panel Control keypad membrane Decorative trim (some models)	Before cleaning the control panel, turn all controls to OFF, active the lockouts (some models) and if needed remove any control knobs from the panel. <b>Do not</b> use abrasive cleaners on any of these materials; they can scratch. Clean using hot, soapy water and a dishcloth. Rinse with a clean water using a dishcloth. Be sure to squeeze excess water from the cloth before wiping the panel; especially when wiping around the controls. Excess water in or around the controls may cause damage to the appliance.
Porcelain enamel parts and door liner	Gentle scouring with a soapy scouring pad will remove most spots. Rinse with a 1:1 solution of clear water and ammonia. If necessary, cover difficult spots with an ammonia-soaked paper towel for 30 to 40 minutes. Rinse with clean water and a damp cloth, and then scrub with a soap-filled scouring pad. Rinse and wipe dry with a clean cloth. Remove all cleaners or the porcelain may become damaged during future heating. Do not allow food spills with high sugar or acid content (milk, tomatoes, sauerkraut, fruit juices or pie filling) to remain on the surface; they may cause a dull spot even after cleaning.
Oven interior	For oven interior, remove excessive spillovers from oven cavity bottom before starting Flex Clean. Clean any soils from oven frame and door liner outside the oven door gasket. For very important cleaning precautions, be sure to read all the instructions in the Flex Clean section.
Porcelain coated oven racks	This oven comes with lubricated porcelain oven racks, which can remain in the oven during the self-clean cycle. Do not clean this vegetable oil lubrication off the racks. It is important that the sides of the oven racks always have a light coating of vegetable oil. To maintain optimal rack performance, re-apply a thin layer of vegetable oil to the sides of the rack after every self-clean cycle or when the rack becomes difficult to slide.
Oven door	Use soap & water to thoroughly clean the top, sides and front of the oven door. Rinse well. You may use a glass cleaner on the outside glass of the oven door. <b>Do not</b> immerse the door in water. <b>Do not spray or allow water or the glass cleaner to enter the door vents.</b> Do not use oven cleaners, cleaning powders or any harsh abrasive cleaning materials on the outside of the oven door.  <b>Do not</b> clean the oven door gasket. The oven door gasket is made of a woven material, on Self-Cleaning models, which is essential for a good seal. Care should be taken not to rub, damage or remove this gasket.
Cooktop surface, surface burners and burner grates.	Do not use spray oven cleaners on the cooktop. See "Cooktop cleaning" and "Cleaning the cooktop and burner grates" later in the Care & Cleaning section.
Stainless Steel (some models)	Only use cleaners and polishes that are specifically manufactured for cleaning stainless steel. Always wipe in direction of metal grain to avoid damaging. Do not use cleaners with high concentrations of chlorides or chlorine. Do not use harsh scrubbing cleaners. Polish with a lint-free cloth. Always be sure to wipe excess cleaner/polish off from the metal surface as bluish stains may occur during future oven heating that cannot be removed. Clean heavier soils with hot, soapy water and a dishcloth. Rinse and dry using clean water and a cloth.

# Care & Cleaning

## Cleaning the Cooktop and Surface Burners

**CAUTION** To avoid possible burns **DO NOT** attempt any of the cooktop cleaning instructions provided before turning OFF all of the surface burners and allow them to completely cool.

**CAUTION** Any additions, changes or conversions required in order for this appliance to satisfactorily meet the application needs must be made by an authorized qualified agency.

Routinely clean the cooktop. Wipe with a clean, damp cloth and wipe dry to avoid scratches.

Keeping the surface burner head ports and slots clean will prevent improper ignition and an uneven flame. See the following sections for more instructions.

### Cleaning recessed and contoured areas of cooktop

If a spill occurs on or in the recessed or contoured areas, blot up spill with an absorbent cloth. Rinse with a clean, damp cloth and wipe dry.

### Cleaning surface burner grates

- Clean only after the grates are completely cool.
- Use nonabrasive plastic scrubbing pad and mild abrasive cleanser or clean in the dishwasher.
- Food soils containing acids may affect the finish. Clean immediately after the grates are cool.
- Thoroughly dry grates **immediately** following cleaning.

### Cleaning burner caps

- Remove caps from burner heads after they have cooled.
- Clean heavy soils with a plastic scrubbing pad and absorbent cloth.
- Thoroughly dry burner caps immediately following cleaning including the bottom and inside of cap.
- Do not use abrasive cleaners. They can scratch porcelain.
- Do not clean burner caps in the dishwasher.
- **Do not operate surface burners without burner caps properly in place. Read important notes.**

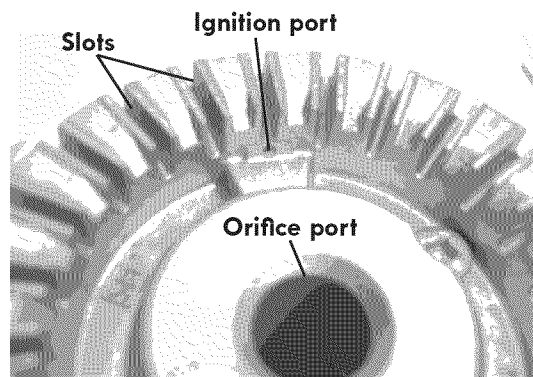

Figure 1- Cooktop regular burner head

### Cleaning surface burner heads

For proper gas flow it may be necessary to clean the burner head and slots. To clean, first use a clean DAMP cloth to soak up any spills. Remove any food from between the burner slots using a small nonabrasive brush like a toothbrush and afterwards wipe up using a damp cloth. For stubborn soils located in the slots, use a small-gauge wire or needle to clean.

Any spill on or around the electrode must be carefully cleaned. Take care not to hit the electrode with anything hard or it could be damaged.

### To clean the burner head ignition ports

Each burner head has a small ignition port located as shown. Should you experience ignition problems it may be that this port hole is partially blocked with soil. With the burner head in place, use a small wire gauge needle or the end of a paper clip to clear the ignition port (See to Fig. 1; round style shown - oval or Dual Ring burner on some models not shown).

### Important notes:

- The surface burner heads are secured to the cooktop and must be cleaned in place on the cooktop.
- **Always** keep the surface burner caps in place **whenever a surface burner is in use.**
- When replacing the burner caps, be sure the burner caps are **seated firmly on top of the burner heads.**
- For proper flow of gas and ignition of burners **DO NOT** allow spills, food, cleaning agents or any other material to enter the gas orifice port opening.

# Care & Cleaning

## Removing and Replacing the Oven Door

**⚠ CAUTION** The oven door is heavy. Be careful when removing and lifting the door. Do not lift the oven door by the handle.

**IMPORTANT** Most oven doors contain glass that can break. Read the following recommendations:

- Do not close the oven door until all the interior oven racks are fully inserted and retracted to the back of the oven.
- Do not hit the glass with pots, pans, or any other object. The oven door glass may break or even break at a later time unexpectedly.
- Scratching, hitting, jarring or stressing the oven door glass may weaken its structure causing an increased risk of breakage at a later time.
- You may use a glass cleaner on the outside of the oven door glass. Do not spray or allow water or the cleaner to enter or drip down into the oven door vents. Spray cleaner on cloth first and then wipe the oven door clean.
- Do not use strong oven cleaners, powders or any harsh abrasive cleaning materials on the outside of the oven door or glass.
- Never clean the oven door gasket. The oven door gasket should always clean during the Self-clean cycle.

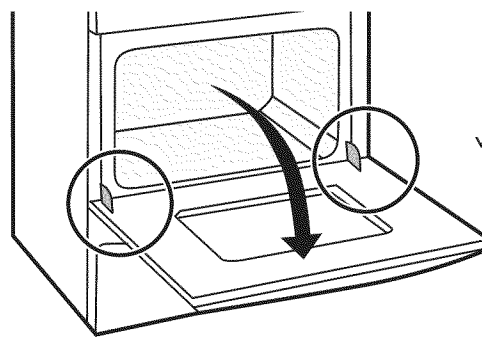

Door Hinge locations with oven door fully open

Figure 1

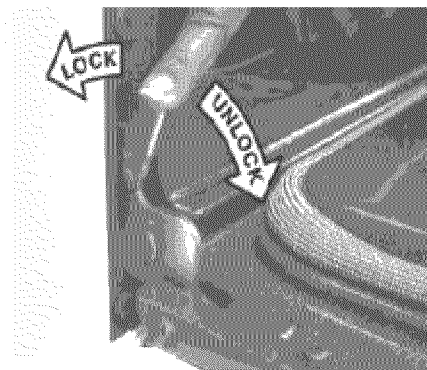

Figure 2

### To Remove Oven Door:

1. Open oven door completely (horizontal with floor - See Figure 1).
2. Pull the door hinge locks on both left and right door hinges down from the oven frame completely towards the oven door (See Figure 2). A tool such as a small flat-blade screwdriver may be required.
3. Firmly grasp both sides of oven door along the door sides (Do not use the oven door handle - See Figure 3).
4. Close the door to the broil stop position (the oven door will stop into this position just before fully closing).
5. With the oven door in the broil stop position, lift the oven door hinge arms over the roller pins located on each side of the oven frame (See Figure 4).

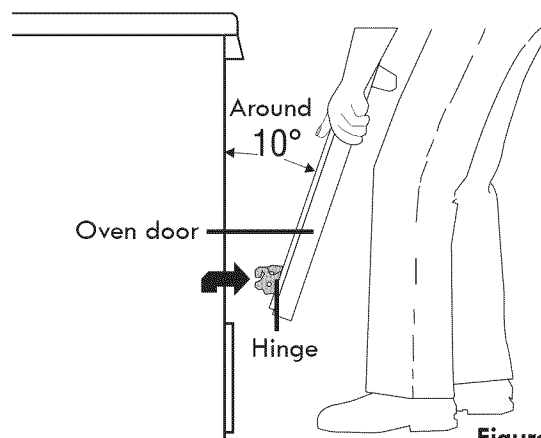

Figure 3

### To Replace Oven Door:

1. Firmly grasp both sides of oven door along the door sides (Do not use the oven door handle - See Figure 3).
2. Holding the oven door at the same angle as the removal position, seat the hook of the hinge arm onto the roller pins located on each side of the oven door frame (See Fig. 4). Also, seat the notch of the hinge arm onto the bottom of the slot at the same time you seat the hook. The hook and notch of the hinge arms must be fully seated onto the roller pins and bottom of the slot.
3. Fully open the oven door (horizontal with floor - See Figure 1).
4. Push the door hinge locks up towards and into the oven frame on both left and right oven door hinges (See Figure 2) to the locked position.
5. Close the oven door.

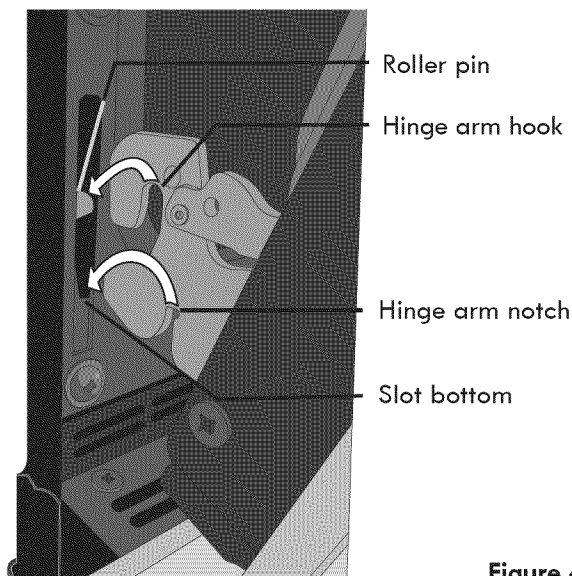

Figure 4

# Care & Cleaning

## Removing and Replacing the Drawer

### To Remove the Drawer:

1. Open the drawer to the fully opened position.
2. Locate glide lever on each side of drawer, pull up on the left glide lever and push down on the right glide lever (See Figure 1).
3. Pull the drawer away from the range.

### To Replace the Drawer:

1. Pull the plastic slider to the front of the glide slots on each side of the drawer cavity (See Figure 2).
2. Align the glide on each side of the drawer with the drawer cavity glide slot.
3. Push the drawer into the drawer cavity until glide levers "click" (approximately 2"). **If you do not hear the glide levers "click" or the drawer does not feel seated remove the drawer and repeat steps 1 thru 3.**

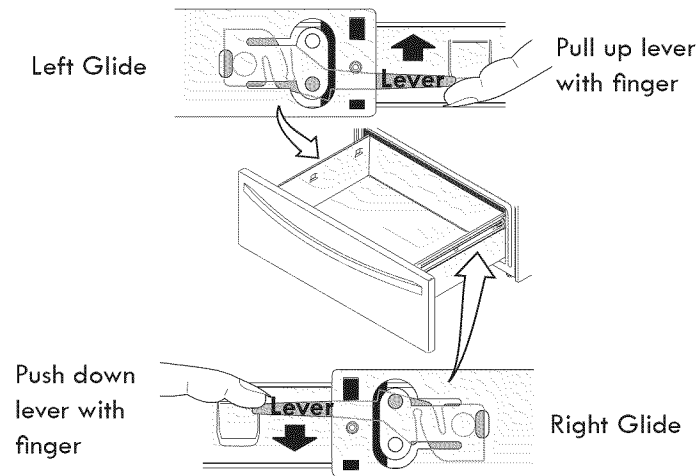

Figure 1

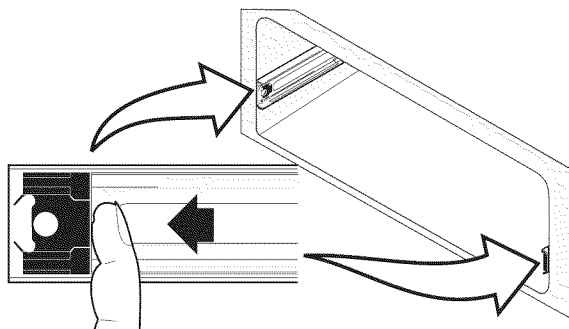



Figure 2

## Replacing the Halogen Oven Light

The oven lights will automatically turn ON when the oven door is opened. The oven lights may also be manually operated by pressing the  pad.

The oven light bulb is covered with a glass shield. The glass shield can be removed to be cleaned manually or to change oven light. **THIS GLASS SHIELD MUST BE IN PLACE WHENEVER THE OVEN IS IN USE.**

### To replace the light bulb:

**CAUTION** BE SURE THE OVEN IS COOL.

1. Turn the power off at the main source.
2. Wear a leather-faced glove for protection against possible broken glass.
3. To remove the glass shield, lift up on side and use force to pull shield out.
4. Replace halogen light appliance bulb taking care not to touch the bulb with your bare fingers. Touching bulb with your skin can leave a film on the bulb that causes it to burn out quickly.
5. Replace glass shield in opposite order and manner of removal.

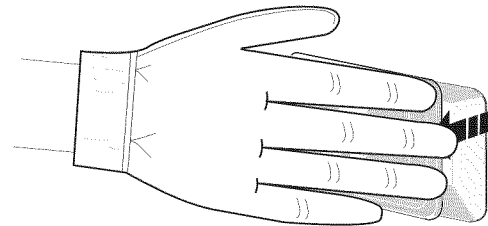

Lift up and pull out.

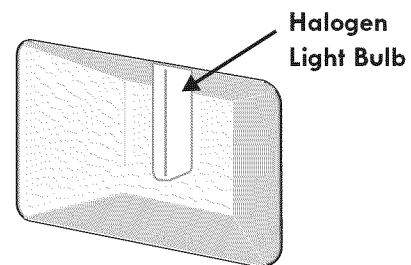



# Before You Call (Solutions to Common Problems)

## Oven Baking

For best cooking results, heat the oven before baking cookies, breads, cakes, pies or pastries, etc. There is no need to preheat the oven for roasting meat or baking casseroles.

The cooking times and temperatures needed to bake a product may vary slightly from your previously owned appliance.

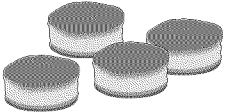
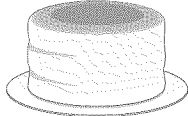
### Baking Problems and Solutions Chart

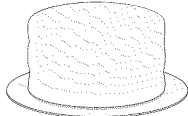
BAKING PROBLEMS	CAUSES	CORRECTIONS
<p><b>Cookies and biscuits burn on the bottom.</b></p> 	<ul style="list-style-type: none"> <li>• Cookies and biscuits put into the oven before the preheating time is completed.</li> <li>• Oven rack overcrowded.</li> <li>• Dark pan absorbs heat too fast.</li> </ul>	<ul style="list-style-type: none"> <li>• Allow oven to preheat to the selected temperature before placing food in oven.</li> <li>• Choose pan sizes that will permit 5.1cm to 10.2cm (2" to 4") of air space on all sides when placed in the oven.</li> <li>• Use a medium-weight aluminum baking sheet.</li> </ul>
<p><b>Cakes too dark on top or bottom.</b></p> 	<ul style="list-style-type: none"> <li>• Cakes put into the oven before preheating time is completed.</li> <li>• Rack position too high or low.</li> <li>• Oven too hot.</li> </ul>	<ul style="list-style-type: none"> <li>• Allow oven to preheat to the selected temperature before placing food in the oven.</li> <li>• Use proper rack position for baking needs.</li> <li>• Set oven temperature 25°F/12°C lower than recommended.</li> </ul>
<p><b>Cakes not done in the center.</b></p> 	<ul style="list-style-type: none"> <li>• Oven too hot.</li> <li>• Incorrect pan size.</li> <li>• Pan not centered in oven.</li> </ul>	<ul style="list-style-type: none"> <li>• Set oven temperature 25°F/12°C lower than recommended.</li> <li>• Use pan size suggested in recipe.</li> <li>• Use proper rack position and place pan so there is 5.1cm to 10.2cm (2" to 4") of space on all sides of pan.</li> </ul>
<p><b>Cakes not level.</b></p> 	<ul style="list-style-type: none"> <li>• Range not level.</li> <li>• Pan too close to oven wall or rack overcrowded.</li> <li>• Pan warped.</li> </ul>	<ul style="list-style-type: none"> <li>• Place a marked glass measuring cup filled with water on the center of the oven rack. If the water level is uneven, refer to the installation instructions for leveling the range.</li> <li>• Be sure to allow 5.1cm to 10.2cm (2" to 4") of clearance on all sides of each pan in the oven.</li> <li>• Do not use pans that are dented or warped.</li> </ul>
<p><b>Foods not done when cooking time is up.</b></p> 	<ul style="list-style-type: none"> <li>• Oven too cool.</li> <li>• Oven overcrowded.</li> <li>• Oven door opened too frequently.</li> </ul>	<ul style="list-style-type: none"> <li>• Set oven temperature 25°F/12°C higher than suggested and bake for the recommended time.</li> <li>• Be sure to remove all pans from the oven except the ones to be used for baking.</li> <li>• Open oven door only after shortest recommended baking time.</li> </ul>



## Before You Call (Solutions to Common Problems)

Before you call for service, review this list. It may save you time and expense. The list includes common occurrences that are not the result of defective workmanship or materials in this appliance.

OCCURRENCE	POSSIBLE CAUSE/SOLUTION
Oven Control Beeps and Displays any F code error (example F11). "d-O" is displayed.	Electronic control has detected a fault condition. Press <b>STOP</b> to clear the display and stop the beeping. Reprogram the oven. If a fault reoccurs, record the fault number. Press <b>STOP</b> and call Sears or another qualified servicer. The door was left open and controls set for self-cleaning cycle. Close the door and push <b>STOP</b> pad.
Faulty installation. Range not leveled. Bad cooking results.	Place oven rack in center of oven. Place a level or a marked glass measuring cup filled with water on the center of the oven rack. If the water level is uneven, adjust the leveling legs of the unit (refer to the installation instructions for leveling the range). If the level is still uneven, contact an installing agent to adjust the cabinet cutout flooring. Kitchen cabinet misalignment may make oven appear to be not level. Be sure cabinets are square and level. Contact cabinet maker to correct problem.
Surface burners do not light.	Surface control knob has not been completely turned to LITE. Push in and turn the surface control knob to LITE until burner ignites and then turn the surface control knob to the desired flame size. Burner ports are clogged. Clean burners. See "Cleaning the Burner Grates, Burner Caps and Burner Heads" under General Cleaning. Range power is disconnected from outlet. Be sure cord is securely plugged into the outlet. Electrical power outage. Be sure the gas supply to the range is turned "ON".
Surface burner flame burns half way around.	Burner ports or slots are clogged. With the burner off, use a small-gauge wire or needle to clean ports or slots. Moisture is present after cleaning. Lightly fan the flame and allow the burner to operate until flame is full. Dry the burners thoroughly following instructions under General Cleaning.
Surface burner flame is orange.	Dust particles in main line. Allow the burner to operate a few minutes until flame turns blue. Salt air in coastal areas. A slightly orange flame is unavoidable.
Fan noise during cooking operation.	A cooling fan may automatically turn on and off to cool internal parts. This is normal, and the fan may continue to run even after oven is turned off.
Entire oven does not operate.	When the oven is first plugged in, or when the power supply to the oven has been interrupted, the display will flash. The oven cannot be programmed until the clock is set. Be sure electrical cord is securely connected into the electrical junction box. Cord/plug is not installed and/or connected. Cord is not supplied with oven. Contact Sears or another qualified servicer. Service wiring not complete. Contact Sears or another qualified servicer. Power outage. Check house lights to be sure. Call your local electric company. Short in cord/plug. Replace cord/plug. Controls are not set properly. See instructions under <b>Setting Oven Controls</b> to set the controls. House fuse has blown or circuit breaker has tripped immediately following installation. House fuse may not be fully engaged. Check fuse and screw or engage circuit breaker securely. House fuse has blown or circuit breaker has tripped after the oven has been installed and previously operating. Call Sears or another qualified servicer.

## Before You Call (Solutions to Common Problems)

OCCURRENCE	POSSIBLE CAUSE/SOLUTION
Oven smokes excessively during broiling.	<p>Make sure the oven door is closed. Door should be closed during broiling.</p> <p>Meat too close to the broiler unit. Reposition the rack to provide more clearance between the meat and the broiler. Preheat broil burner for quick searing operation.</p> <p>Meat not properly prepared. Remove excess fat from meat. Slash remaining fatty edges to prevent curling, but do not cut into the lean.</p> <p>Grid on broiler pan wrong side-up. Grease does not drain into broiler pan. Always place the grid on the broiler pan with the ribs up and the slots down to allow grease to drip into the pan.</p> <p>Broiler pan used without grid or grid cover with foil. <b>DO NOT</b> use the broiler pan without the grid or cover the grid with foil.</p> <p>Oven needs to be cleaned. Grease has built up on oven surfaces. Regular cleaning is necessary when broiling frequently. Old grease or food spatters cause excessive smoking.</p>
Poor baking results. Oven too cool or too hot.	<p>Many factors affect baking results. See <b>Oven Baking</b> for hints, causes and corrections. See <b>Adjusting Oven Temperature</b>.</p>
Self-cleaning cycle does not work.	<p>Make sure the oven door is closed.</p> <p>Controls not set properly. Follow Self-Cleaning instructions in this Use &amp; Care Guide.</p> <p>Self-cleaning cycle was interrupted. Stop time must be set 2-4 hours past the start time. Follow steps under "Stopping or Interrupting a Self-Cleaning Cycle" in this Use &amp; Care Guide.</p>
Soil not completely removed after self-cleaning cycle is completed.	<p>Before starting the Self-Cleaning cycle, hand clean any soil from the oven frame, the door liner outside the oven door gasket, and the small area at the front center of the oven. These surfaces are not in the self-cleaning area. Clean with soap and water. Burned-on residue can be cleaned off with a stiff nylon brush and water or nylon scrubber. <b>DO NOT</b> hand clean the oven door gasket or it will be permanently damaged.</p> <p>Excessive spillovers in oven. Set the self-clean cycle for longer cleaning time.</p>
Flames inside oven or smoke from vent.	<p>Excessive spillovers in oven. This is normal, especially for high oven temperatures, pie spillovers or for large amounts of grease on bottom of oven. Wipe up excessive pie filling spillovers.</p>

# PROTECTION AGREEMENTS

## Master Protection Agreements

*Congratulations on making a smart purchase. Your new Kenmore® product is designed and manufactured for years of dependable operation. But like all products, it may require preventive maintenance or repair from time to time. That's when having a Master Protection Agreement can save you money and aggravation.*

The Master Protection Agreement also helps extend the life of your new product. Here's what the Agreement\* includes:

- ☑ **Parts and labor** needed to help keep products operating properly **under normal use**, not just defects. Our coverage goes **well beyond the product warranty**. No deductibles, no functional failure excluded from coverage – **real protection**.
- ☑ **Expert service** by a force of more than **10,000 authorized Sears service technicians**, which means someone you can trust will be working on your product.
- ☑ **Unlimited service calls and nationwide service**, as often as you want us, whenever you want us.
- ☑ **«No-lemon» guarantee** – replacement of your covered product if four or more product failures occur within twelve months.
- ☑ **Product replacement** if your covered product can't be fixed.
- ☑ **Annual Preventive Maintenance Check** at your request – no extra charge.
- ☑ **Fast help by phone** – we call it **Rapid Resolution** – phone support from a Sears representative on all products. Think of us as a «talking owner's manual».
- ☑ **Power surge protection** against electrical damage due to power fluctuations.
- ☑ **\$250 Food Loss Protection** annually for any food spoilage that is the result of mechanical failure of any covered refrigerator or freezer.
- ☑ **Rental reimbursement** if repair of your covered product takes longer than promised.
- ☑ **10% discount** off the regular price of any non-covered repair service and related installed parts.

Once you purchase the Agreement, a simple phone call is all that it takes for you to schedule service. You can call anytime day or night, or schedule a service appointment online.

The Master Protection Agreement is a risk free purchase. If you cancel for any reason during the product warranty period, we will provide a full refund. Or, a prorated refund anytime after the product warranty period expires. Purchase your Master Protection Agreement today!

**Some limitations and exclusions apply. For prices and additional information in the U.S.A. call 1-800-827-6655.**

**\* Coverage in Canada varies on some items. For full details call Sears Canada at 1-800-361-6665.**

## Sears Installation Service

*For Sears professional installation of home appliances, garage door openers, water heaters, and other major home items, in the U.S.A. or Canada call **1-800-4-MY-HOME**®.*

## Acuerdos maestros de protección

*Enhorabuena por haber hecho una compra inteligente. Su nuevo producto Kenmore® está diseñado y fabricado para brindarle años de funcionamiento fiable. Pero, como cualquier producto, puede necesitar mantenimiento preventivo o reparaciones periódicas. Es por eso que tener un Acuerdo maestro de protección podría ahorrarle dinero y molestias.*

El Acuerdo maestro de protección también sirve para prolongar la durabilidad de su nuevo producto. El acuerdo\* incluye lo siguiente:

- ☑ **Piezas y mano de obra** necesarias para contribuir a mantener el funcionamiento adecuado de los productos **utilizados en condiciones normales de uso**, no sólo en caso de defectos de los productos. Nuestra cobertura va **mucho más allá que la garantía del producto**. No se aplican deducibles ni exclusiones por fallas del funcionamiento: es decir, **verdadera protección**.
- ☑ **Servicio técnico por expertos** (más de **10000 técnicos autorizados de Sears**), lo cual significa que quien repare o realice el mantenimiento de su producto será un profesional de confianza.
- ☑ **Servicio técnico a escala nacional y número ilimitado de llamadas de solicitud de servicio técnico**: se puede poner en contacto con nosotros cuantas veces lo desee y cuando lo desee.
- ☑ **Garantía «sin sorpresas»**: se reemplaza el producto cubierto por el acuerdo si ocurren cuatro o más fallas del producto en un periodo de 12 meses.
- ☑ **Reemplazo del producto**: en caso de que no se pueda reparar el producto cubierto por el acuerdo.
- ☑ **Revisión anual preventiva de mantenimiento del producto**: puede solicitarla en cualquier momento, sin costo alguno.
- ☑ **Rápida asistencia telefónica**, la cual denominamos **Solución rápida**: es decir, asistencia telefónica a través de cualquiera de nuestros representantes de Sears, sobre cualquiera de nuestros productos. Piense en nosotros como en un «manual parlante del usuario».
- ☑ **Protección contra fallas eléctricas**, contra daños debidos a fluctuaciones de la corriente eléctrica.
- ☑ **\$250 al año para cubrir cualquier posible deterioro de alimentos** que haya tenido que desechar debido a una falla mecánica de cualquiera de nuestros refrigeradores o congeladores cubiertos por este acuerdo.
- ☑ **Devolución de gastos de alquiler de electrodomésticos** si la reparación de su producto asegurado toma más que el tiempo prometido.
- ☑ **10% de descuento** aplicable tanto a los costos del servicio de reparación, como de las piezas instaladas relacionadas que no hayan quedado cubiertos por este acuerdo.

Una vez que haya realizado el pago de este acuerdo, bastará una simple llamada telefónica para concertar una visita de servicio. Puede llamar a cualquier hora del día o de la noche, o bien concertar una visita de servicio por Internet.

La adquisición del Acuerdo maestro de protección es una inversión exenta de riesgos. Si por cualquier motivo decide cancelar dicho acuerdo durante el periodo de garantía del producto, le haremos un reintegro total del valor. O bien un importe proporcional si cancela el acuerdo en cualquier otro momento posterior al vencimiento del periodo de garantía del producto. ¡Adquiera hoy mismo su Acuerdo maestro de protección!

**Algunas limitaciones y exclusiones podrían aplicarse. Para solicitar precios e información adicional, llame al 1-800-827-6655 (en los EE.UU.).**

**\* La cobertura en Canadá varía en el caso de algunos artículos. Para obtener detalles completos al respecto, llame al 1-800-361-6665 de Sears de Canadá.**

## Servicio de instalación de Sears

*Para solicitar la instalación por profesionales de Sears de electrodomésticos, abridores de puertas de garaje, calentadores de agua y otros artículos de uso prioritario en el hogar, llame al **1-800-4-MY-HOME** en los EE.UU. o Canadá.*

# Get it fixed, at your home or ours!

## Your Home

For troubleshooting, product manuals and expert advice:



[www.managemylife.com](http://www.managemylife.com)

For repair – **in your home** – of **all** major brand appliances, lawn and garden equipment, or heating and cooling systems, **no matter who made it, no matter who sold it!**

For the replacement parts, accessories and owner's manuals that you need to do-it-yourself.

For Sears professional installation of home appliances and items like garage door openers and water heaters.

**1-800-4-MY-HOME<sup>®</sup>** (1-800-469-4663)

Call anytime, day or night (U.S.A. and Canada)

[www.sears.com](http://www.sears.com)

[www.sears.ca](http://www.sears.ca)

## Our Home

For repair of carry-in items like vacuums, lawn equipment, and electronics, call anytime for the location of your nearest

**Sears Parts & Repair Service Center**

**1-800-488-1222** (U.S.A.)

[www.sears.com](http://www.sears.com)

**1-800-469-4663** (Canada)

[www.sears.ca](http://www.sears.ca)

To purchase a protection agreement on a product serviced by Sears:

**1-800-827-6655** (U.S.A.)

**1-800-361-6665** (Canada)

Para pedir servicio de reparación a domicilio, y para ordenar piezas:

**1-888-SU-HOGAR<sup>®</sup>**

(1-888-784-6427)

[www.sears.com](http://www.sears.com)

Au Canada pour service en français:

**1-800-LE-FOYER<sup>MC</sup>**

(1-800-533-6937)

[www.sears.ca](http://www.sears.ca)

The Sears logo, featuring the word "Sears" in a large, bold, serif font with a stylized 'S'.

® Registered Trademark / <sup>TM</sup> Trademark of KCD IP, LLC in the United States, or Sears Brands, LLC in other countries

® Marca Registrada / <sup>TM</sup> Marca de Fábrica de KCD IP, LLC en Estados Unidos, o Sears Brands, LLC in otros países

<sup>MC</sup> Marque de commerce / <sup>MD</sup> Marque déposée de Sears Brands, LLC